

Eurocard Connectors 2.54mm Pitch

Type R (Reverse)

Right Angle Receptacle Assemblies

Material

Housing - Polyester, grey

Contacts - Copper Alloy

DIN Class 2 Plating - 15u" Gold Plating on Mating

Area. Tin Plating on Tail Area.

Nickel Underplate Allover

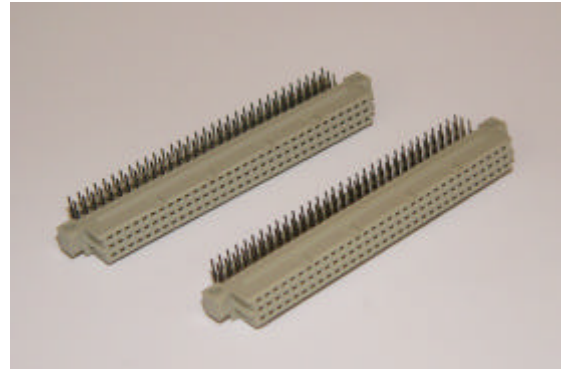

All dimensions in mm

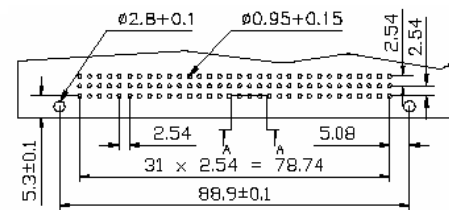
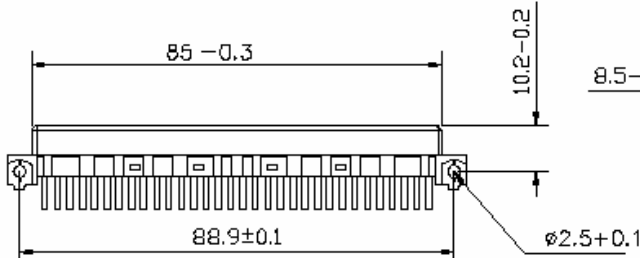
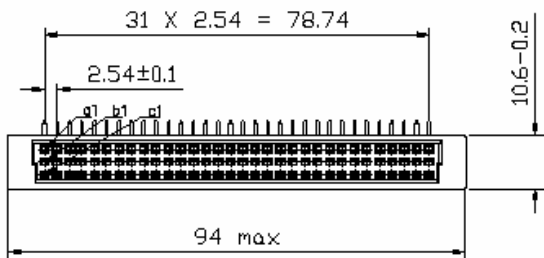

Recommended PCB Hole Layout

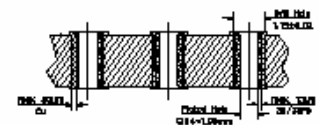
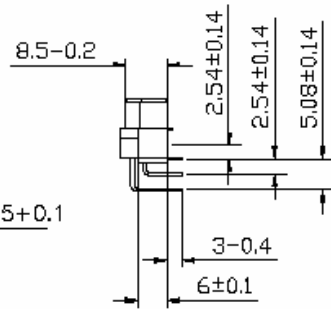

RECOMMENDED HOLE SPECIFICATIONS SECTION A-A

How to order

Part Number Information		I	II	III	IV - VI	VII
		N	8	0	xxx	-X
I	N - DIN 41612 Connectors					
II	1 - Type B	2 - Type C				
	3 - Type D	4 - Type E				
	5 - Type F	6 - Type H				
	7 - Type Q	8 - Type R				
	9 - Type M	0 - Accessories				
III	0 - Female	1 - Male				
	2 - 1/2 Sizes Female (R/2)	3 - 1/2 Sizes Male (R/2)				
	4 - 1/3 Size Female (R/3)	5 - 1/3 Size Male (R/3)				
	6 - Extend Size Female	7 - Extend Size Male				
	8 -	9 - Guide frame				
IV	xxx	Please Consult to Sales Representative to Fix the Optional				
VII	X	1- Class 1	3-Class 3	Omit-Class 2		

Eurocard Connectors 2.54mm Pitch

Type R (Reverse)

Right Angle Receptacle Assemblies

**R ac Row
Soldering**

Ordering Information

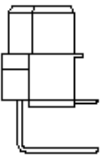
	Number of Pin	Class 2	Class 3	Option
	64	N80101	N80101-3	
	32	N80103	N80103-3	2,4,6...32 5.08mm Pitch

**R abc Row
Soldering**

Ordering Information

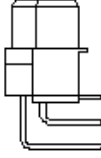
	Number of Pin	Class 2	Class 3	Option
	96	N80102	N80102-3	
	48	N80104	N80104-3	2,4,6...32 5.08mm Pitch

Soldering with clips

Ordering Information

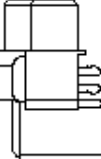
	Number of Pin	Class 2	Class 3	Option
	64	N80111	N80111-3	
	32	N80113	N80113-3	2,4,6...32 5.08mm Pitch

Soldering with clips

Ordering Information

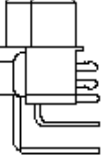
	Number of Pin	Class 2	Class 3	Option
	96	N80112	N80112-3	
	48	N80114	N80114-3	2,4,6...32 5.08mm Pitch

**R ac Row
Press-fit**

Ordering Information

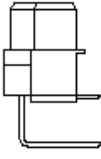
	Number of Pin	Class 2	Class 3	Option
	64	N80201	N80201-3	
	32	N80203	N80203-3	2,4,6...32 5.08mm Pitch
Available upon request				

**R abc Row
Press-fit**

Ordering Information

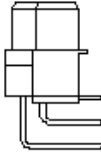
	Number of Pin	Class 2	Class 3	Option
	96	N80202	N80202-3	
	48	N80204	N80204-3	2,4,6...32 5.08mm Pitch
Available upon request				

Eurocard Connectors 2.54mm Pitch

Type R (Reverse)
Vertical Pin Assemblies

Material

Housing - Polyester, grey

Contacts - Copper Alloy

DIN Class 2 Plating - 15u" Gold Plating on Mating

Area. Tin Plating on Tail Area.

Nickel Underplate Allover



All dimensions in mm

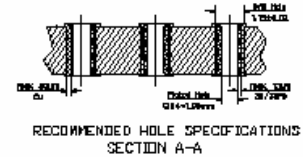
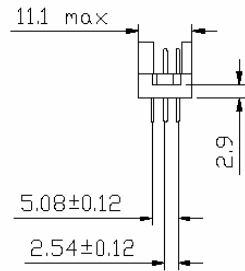
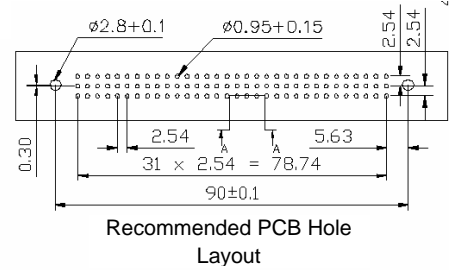
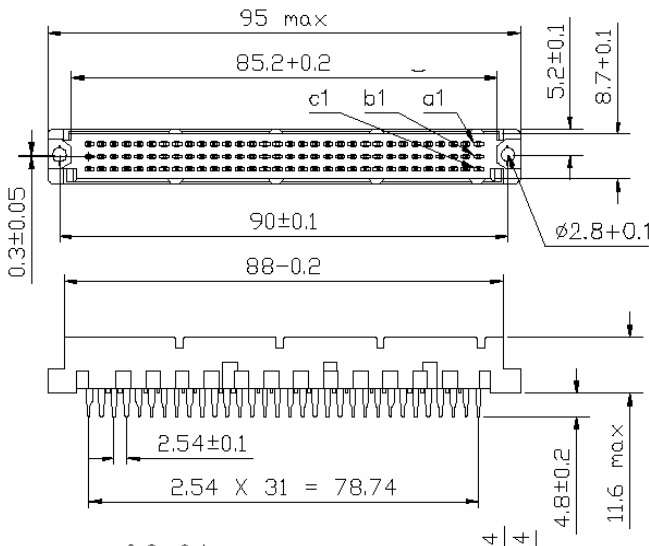

How to order

Part Number Information	I	II	III	IV - VI	VII
	N	8	1	xxx	-X
I	N - DIN 41612 Connectors				
II	1 - Type B	2 - Type C			
	3 - Type D	4 - Type E			
	5 - Type F	6 - Type H			
	7 - Type Q	8 - Type R			
	9 - Type M	0 - Accessories			
III	0 - Female	1 - Male			
	2 - 1/2 Sizes Female (R/2)	3 - 1/2 Sizes Male (R/2)			
	4 - 1/3 Size Female (R/3)	5 - 1/3 Size Male (R/3)			
	6 - Extend Size Female	7 - Extend Size Male			
	8 -	9 - Guide frame			
IV	xxx	Please Consult to Sales Representative to Fix the Optional			
VII	X	1- Class 1	3-Class 3	Omit-Class 2	

Eurocard Connectors 2.54mm Pitch

Type R (Reverse)

Vertical Pin Assemblies

**R ac Row
Soldering**

Ordering Information

	Number of Pin	Class 2	Class 3	Option
	64	N81111	N81111-3	
	32	N81113	N81113-3	2,4,6...32 5.08mm Pitch

**R abc Row
Soldering**

Ordering Information

	Number of Pin	Class 2	Class 3	Option
	96	N81112	N81112-3	
	48	N81114	N81114-3	2,4,6...32 5.08mm Pitch

Soldering Long Tail 13mm

Ordering Information

	Number of Pin	Class 2	Class 3	Option
	64	N81551	N81551-3	
	32	N81553	N81553-3	2,4,6...32 5.08mm Pitch

Soldering Long Tail 13mm

Ordering Information

	Number of Pin	Class 2	Class 3	Option
	96	N81552	N81552-3	
	48	N81554	N81554-3	2,4,6...32 5.08mm Pitch

Soldering Long Tail 13mm

Full Gold Plating

Ordering Information

	Number of Pin	Class 2	Class 3	Option
	64	N81581	N81581-3	
	32	N81583	N81583-3	2,4,6...32 5.08mm Pitch

Soldering Long Tail 13mm

Full Gold Plating

Ordering Information

	Number of Pin	Class 2	Class 3	Option
	96	N81582	N81582-3	
	48	N81584	N81584-3	2,4,6...32 5.08mm Pitch

Type R (Reverse)

Vertical Pin Assemblies

R ac Row

Press Fit

Ordering Information

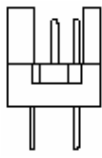
	Number of Pin	Class 2	Class 3	Option
	64	N81221	N81221-3	
	32	N81213	N81213-3	2,4,6...32 5.08mm Pitch

R abc Row

Press Fit

Ordering Information

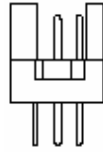
	Number of Pin	Class 2	Class 3	Option
	96	N81262	N81262-3	
	48	N81214	N81214-3	2,4,6...32 5.08mm Pitch

Press Fit Long Tail 13mm

Ordering Information

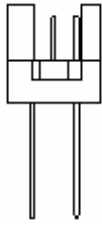
	Number of Pin	Class 2	Class 3	Option
	64	N81621	N81621-3	
	32	N81613	N81613-3	2,4,6...32 5.08mm Pitch

Press Fit Long Tail 13mm

Ordering Information

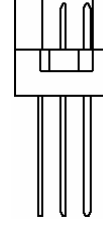
	Number of Pin	Class 2	Class 3	Option
	96	N81622	N81622-3	
	48	N81624	N81624-3	2,4,6...32 5.08mm Pitch

Press Fit Long Tail 13mm

Full Gold Plating

Ordering Information

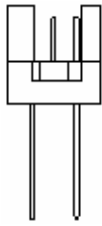
	Number of Pin	Class 2	Class 3	Option
	64	N81614	N81614-3	
	32	N81693	N81693-3	2,4,6...32 5.08mm Pitch

Press Fit Long Tail 13mm

Full Gold Plating

Ordering Information

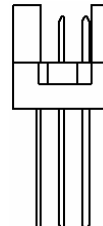
	Number of Pin	Class 2	Class 3	Option
	96	N81662	N81662-3	
	48	N81694	N81694-3	2,4,6...32 5.08mm Pitch

Eurocard Connectors 2.54mm Pitch

Type R/2 (Reverse Half Sizes)

Right Angle Receptacle Assemblies

Material

Housing - Polyester, grey

Contacts - Copper Alloy

DIN Class 2 Plating - 15u" Gold Plating on Mating

Area. Tin Plating on Tail Area.

Nickel Underplate Allover



All dimensions in mm

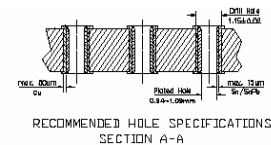
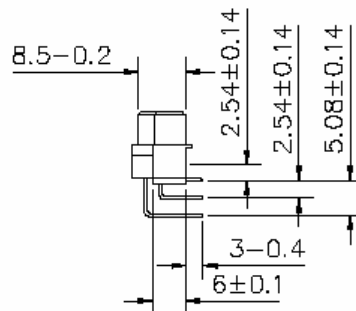
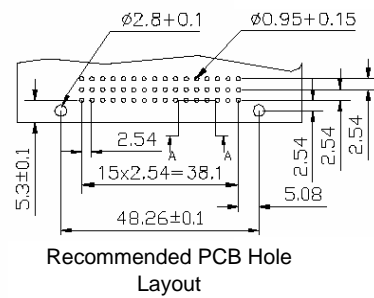
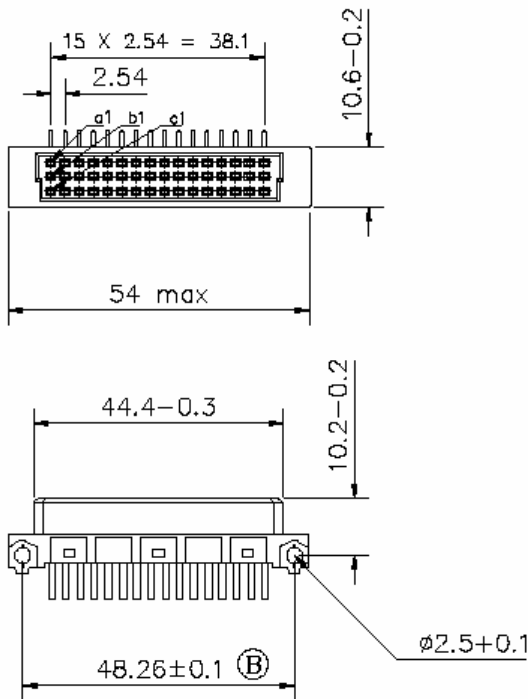

How to order

Part Number Information	I	II	III	IV - VI	VII
	N	8	2	xxx	-X
I	N - DIN 41612 Connectors				
II	1 - Type B	2 - Type C			
	3 - Type D	4 - Type E			
	5 - Type F	6 - Type H			
	7 - Type Q	8 - Type R			
	9 - Type M	0 - Accessories			
III	0 - Female	1 - Male			
	2 - 1/2 Sizes Female (R/2)	3 - 1/2 Sizes Male (R/2)			
	4 - 1/3 Size Female (R/3)	5 - 1/3 Size Male (R/3)			
	6 - Extend Size Female	7 - Extend Size Male			
	8 -	9 - Guide frame			
IV	xxx	Please Consult to Sales Representative to Fix the Optional			
VII	X	1- Class 1	3-Class 3	Omit-Class 2	

Type R/2 (Reverse Half Sizes)

Right Angle Receptacle Assemblies

R/2 ac Row

Soldering

Ordering Information

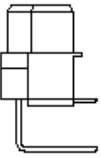
	Number of Pin	Class 2	Class 3	Option
	32	N82101	N82101-3	
	16	N82103	N82103-3	2,4,6...32 5.08mm Pitch

R/2 abc Row

Soldering

Ordering Information

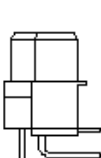
	Number of Pin	Class 2	Class 3	Option
	48	N82102	N82102-3	
	24	N82104	N82104-3	2,4,6...32 5.08mm Pitch

Soldering with clips

Ordering Information

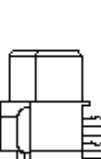
	Number of Pin	Class 2	Class 3	Option
	32	N82111	N82111-3	
	16	N82113	N82113-3	2,4,6...32 5.08mm Pitch

Soldering with clips

Ordering Information

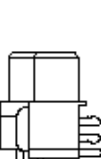
	Number of Pin	Class 2	Class 3	Option
	48	N82112	N82112-3	
	24	N82114	N82114-3	2,4,6...32 5.08mm Pitch

R/2 ac Row

Press-fit

Ordering Information

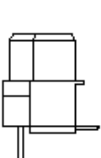
	Number of Pin	Class 2	Class 3	Option
	32	N82201	N82201-3	
	16	N82203	N82203-3	2,4,6...32 5.08mm Pitch
Available upon request				

R/2 abc Row

Press-fit

Ordering Information

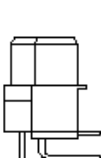
	Number of Pin	Class 2	Class 3	Option
	48	N82202	N82202-3	
	24	N82204	N82204-3	2,4,6...32 5.08mm Pitch
Available upon request				

Eurocard Connectors 2.54mm Pitch

Type R/2 (Reverse Half Sizes)
Vertical Pin Assemblies

Material

Housing - Polyester, grey

Contacts - Copper Alloy

DIN Class 2 Plating - 15u" Gold Plating on Mating Area. Tin Plating on Tail Area.

Nickel Underplate Allover

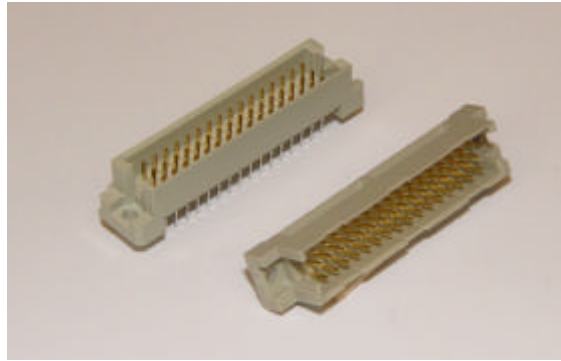

All dimensions in mm

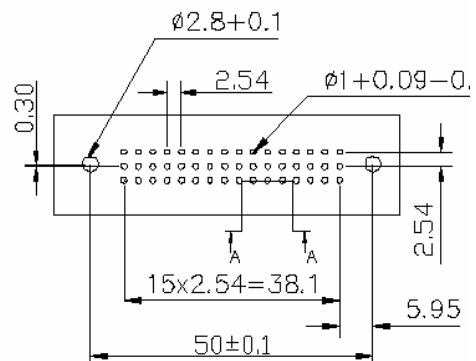
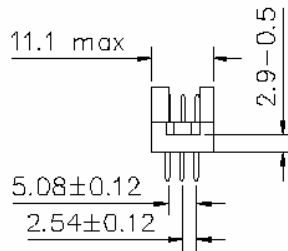
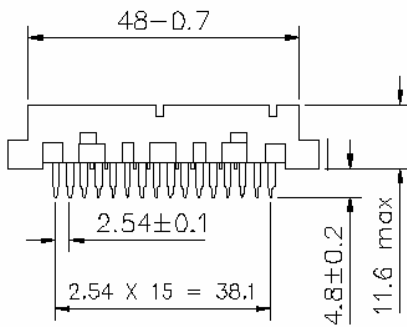
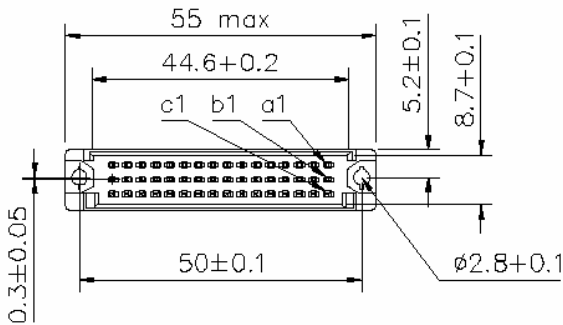

Recommended PCB Hole Layout
Component Side

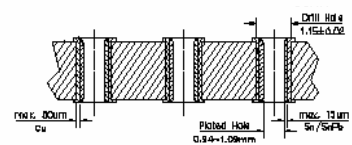

RECOMMENDED HOLE SPECIFICATIONS
SECTION A-A

How to order

Part Number Information		I	II	III	IV - VI	VII
		N	8	3	xxx	-X
I	N - DIN 41612 Connectors					
II	1 - Type B	2 - Type C				
	3 - Type D	4 - Type E				
	5 - Type F	6 - Type H				
	7 - Type Q	8 - Type R				
	9 - Type M	0 - Accessories				
III	0 - Female	1 - Male				
	2 - 1/2 Sizes Female (R/2)	3 - 1/2 Sizes Male (R/2)				
	4 - 1/3 Size Female (R/3)	5 - 1/3 Size Male (R/3)				
	6 - Extend Size Female	7 - Extend Size Male				
	8 -	9 - Guide frame				
IV	xxx	Please Consult to Sales Representative to Fix the Optional				
VII	X	1-Class 1	3-Class 3	Omit-Class 2		

Type R/2 (Reverse Half Sizes)

Vertical Pin Assemblies

R/2 ac Row

Soldering

Ordering Information

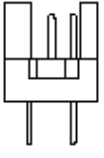
	Number of Pin	Class 2	Class 3	Option
	32	N83101	N83101-3	
	16	N83103	N83103-3	2,4,6...32 5.08mm Pitch

R/2 abc Row

Soldering

Ordering Information

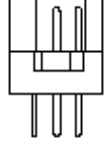
	Number of Pin	Class 2	Class 3	Option
	48	N83102	N83102-3	
	24	N83104	N83104-3	2,4,6...32 5.08mm Pitch

Soldering Long Tail 13mm

Ordering Information

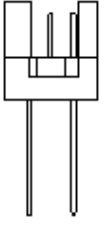
	Number of Pin	Class 2	Class 3	Option
	32	N83301	N83301-3	
	16	N83303	N83303-3	2,4,6...32 5.08mm Pitch

Soldering Long Tail 13mm

Ordering Information

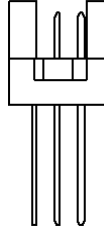
	Number of Pin	Class 2	Class 3	Option
	48	N83302	N83302-3	
	24	N83304	N83304-3	2,4,6...32 5.08mm Pitch

Soldering Long Tail 13mm

Full Gold Plating

Ordering Information

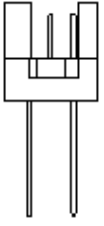
	Number of Pin	Class 2	Class 3	Option
	32	N83501	N83501-3	
	16	N83503	N83503-3	2,4,6...32 5.08mm Pitch

Soldering Long Tail 13mm

Full Gold Plating

Ordering Information

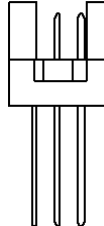
	Number of Pin	Class 2	Class 3	Option
	48	N83502	N83502-3	
	24	N83504	N83504-3	2,4,6...32 5.08mm Pitch

Eurocard Connectors 2.54mm Pitch

Type R/2 (Reverse Half Sizes)

Vertical Pin Assemblies

R/2 ac Row

Press Fit

Ordering Information

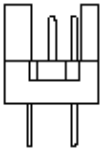
	Number of Pin	Class 2	Class 3	Option
	32	N83201	N83201-3	
	16	N83203	N83203-3	2,4,6...32 5.08mm Pitch

R/2 abc Row

Press Fit

Ordering Information

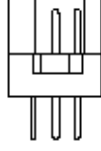
	Number of Pin	Class 2	Class 3	Option
	48	N83202	N83202-3	
	24	N83204	N83204-3	2,4,6...32 5.08mm Pitch

Press Fit Long Tail 13mm

Ordering Information

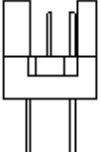
	Number of Pin	Class 2	Class 3	Option
	32	N83401	N83401-3	
	16	N83403	N83403-3	2,4,6...32 5.08mm Pitch

Press Fit Long Tail 13mm

Ordering Information

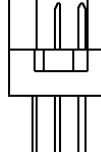
	Number of Pin	Class 2	Class 3	Option
	48	N83402	N83402-3	
	24	N83404	N83404-3	2,4,6...32 5.08mm Pitch

Press Fit Long Tail 13mm

Full Gold Plating

Ordering Information

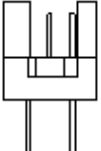
	Number of Pin	Class 2	Class 3	Option
	32	N83601	N83601-3	
	16	N83603	N84603-3	2,4,6...32 5.08mm Pitch

Press Fit Long Tail 13mm

Full Gold Plating

Ordering Information

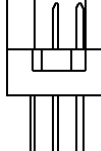
	Number of Pin	Class 2	Class 3	Option
	48	N83602	N83602-3	
	24	N83604	N83604-3	2,4,6...32 5.08mm Pitch

Eurocard Connectors 2.54mm Pitch

Type R/3 (Reverse 1/3 Sizes)
 Right Angle Receptacle Assemblies

Material

Housing - Polyester, grey

Contacts - Copper Alloy

DIN Class 2 Plating - 15u" Gold Plating on Mating

Area. Tin Plating on Tail Area.

Nickel Underplate Allover



All dimensions in mm

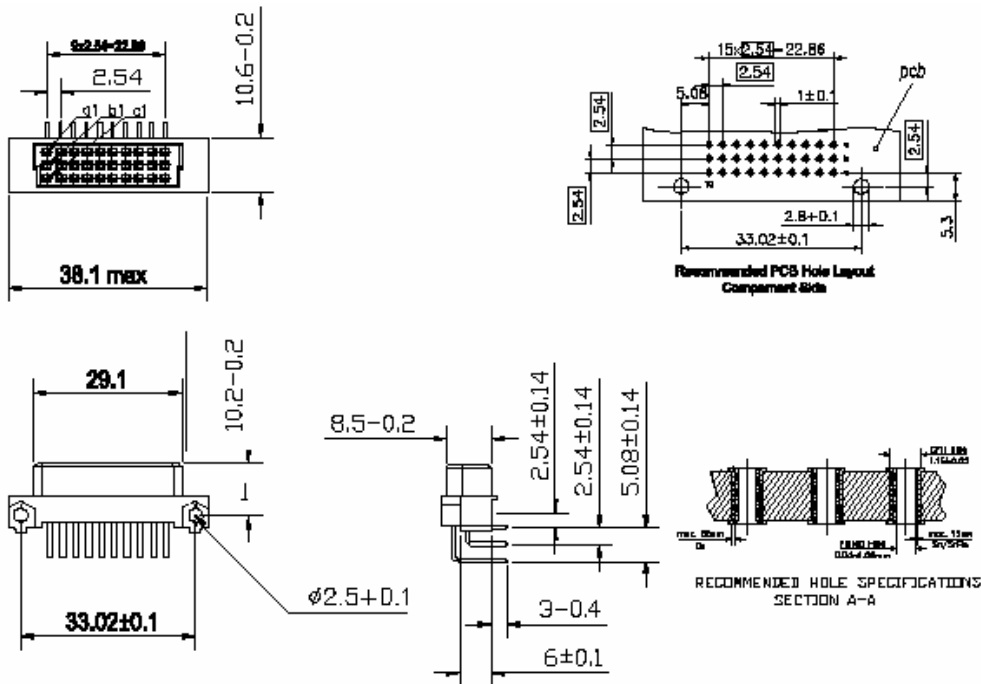

How to order

Part Number Information	I	II	III	IV - VI	VII
	N	8	4	xxx	-X
I	N - DIN 41612 Connectors				
II	1 - Type B	2 - Type C			
	3 - Type D	4 - Type E			
	5 - Type F	6 - Type H			
	7 - Type Q	8 - Type R			
	9 - Type M	0 - Accessories			
III	0 - Female	1 - Male			
	2 - 1/2 Sizes Female (R/2)	3 - 1/2 Sizes Male (R/2)			
	4 - 1/3 Size Female (R/3)	5 - 1/3 Size Male (R/3)			
	6 - Extend Size Female	7 - Extend Size Male			
	8 -	9 - Guide frame			
IV	xxx	Please Consult to Sales Representative to Fix the Optional			
VII	X	1- Class 1	3-Class 3	Omit-Class 2	

Eurocard Connectors 2.54mm Pitch

**Type R/3 (Reverse 1/3 Sizes)
Right Angle Receptacle Assemblies**

**R/3 ac Row
Soldering**

Ordering Information

	Number of Pin	Class 2	Class 3	Option
	20	N84101	N84101-3	
	10	N84103	N84103-3	2,4,6...32 5.08mm Pitch
Available upon request				

**R/3 abc Row
Soldering**

Ordering Information

	Number of Pin	Class 2	Class 3	Option
	30	N84102	N84102-3	
	15	N84104	N84104-3	2,4,6...32 5.08mm Pitch
Available upon request				

**Soldering with clips
Ordering Information**

	Number of Pin	Class 2	Class 3	Option
	20	N84111	N84111-3	
	10	N84113	N84113-3	2,4,6...32 5.08mm Pitch
Available upon request				

**Soldering with clips
Ordering Information**

	Number of Pin	Class 2	Class 3	Option
	30	N84112	N84112-3	
	15	N84114	N84114-3	2,4,6...32 5.08mm Pitch
Available upon request				

**R/3 ac Row
Press-fit**

Ordering Information

	Number of Pin	Class 2	Class 3	Option
	20	N84201	N84201-3	
	10	N84203	N84203-3	2,4,6...32 5.08mm Pitch
Available upon request				

**R/3 abc Row
Press-fit**

Ordering Information

	Number of Pin	Class 2	Class 3	Option
	30	N84202	N84202-3	
	15	N84204	N84204-3	2,4,6...32 5.08mm Pitch
Available upon request				

Material

Housing - Polyester, grey

Contacts - Copper Alloy

DIN Class 2 Plating - 15u" Gold Plating on Mating Area. Tin Plating on Tail Area.

Nickel Underplate Allover

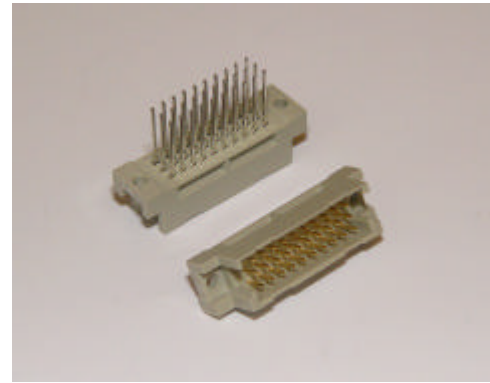

All dimensions in mm

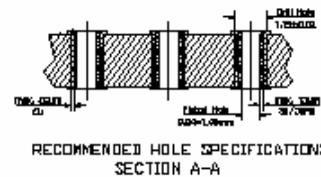
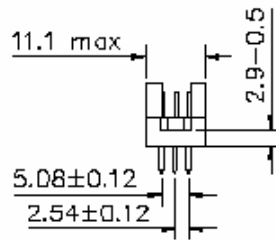
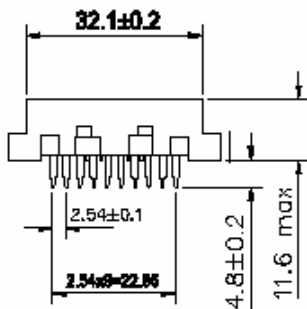
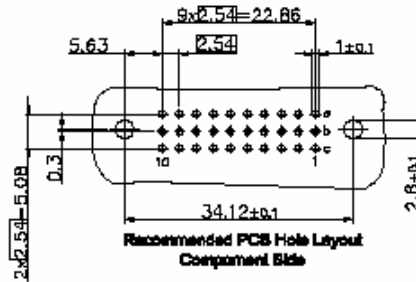
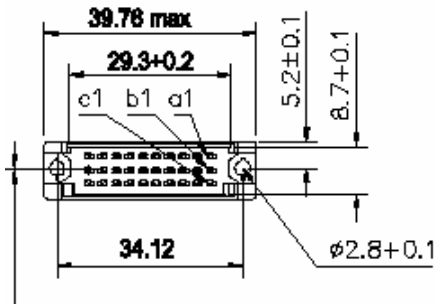

How to order

Part Number Information		I	II	III	IV - VI	VII
		N	8	5	xxx	-X
I	N - DIN 41612 Connectors					
II	1 - Type B	2 - Type C				
	3 - Type D	4 - Type E				
	5 - Type F	6 - Type H				
	7 - Type Q	8 - Type R				
	9 - Type M	0 - Accessories				
III	0 - Female	1 - Male				
	2 - 1/2 Sizes Female (R/2)	3 - 1/2 Sizes Male (R/2)				
	4 - 1/3 Size Female (R/3)	5 - 1/3 Size Male (R/3)				
	6 - Extend Size Female	7 - Extend Size Male				
	8 -	9 - Guide frame				
IV	xxx	Please Consult to Sales Representative to Fix the Optional				
VII	X	1- Class 1	3-Class 3	Omit-Class 2		

Eurocard Connectors 2.54mm Pitch

**Type R/3 (Reverse 1/3 Sizes)
Vertical Pin Assemblies**

**R/3 ac Row
Soldering**

Ordering Information

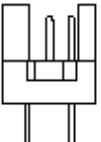
	Number of Pin	Class 2	Class 3	Option
	20	N85101	N85101-3	
	10	N85103	N85103-3	2,4,6...32 5.08mm Pitch

**R/3 abc Row
Soldering**

Ordering Information

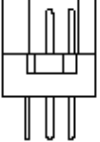
	Number of Pin	Class 2	Class 3	Option
	30	N85102	N85102-3	
	15	N85104	N85104-3	2,4,6...32 5.08mm Pitch

Soldering Long Tail 13mm

Ordering Information

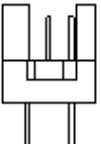
	Number of Pin	Class 2	Class 3	Option
	20	N85301	N85301-3	
	10	N85303	N85303-3	2,4,6...32 5.08mm Pitch

Soldering Long Tail 13mm

Ordering Information

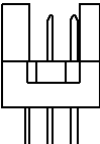
	Number of Pin	Class 2	Class 3	Option
	30	N85302	N85302-3	
	15	N85304	N85304-3	2,4,6...32 5.08mm Pitch

Soldering Long Tail 13mm

Full Gold Plating

Ordering Information

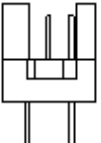
	Number of Pin	Class 2	Class 3	Option
	20	N85501	N85501-3	
	10	N85503	N85503-3	2,4,6...32 5.08mm Pitch

Soldering Long Tail 13mm

Full Gold Plating

Ordering Information

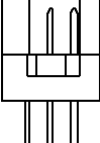
	Number of Pin	Class 2	Class 3	Option
	30	N85502	N85502-3	
	15	N85504	N85504-3	2,4,6...32 5.08mm Pitch

Eurocard Connectors 2.54mm Pitch

**Type R/2 (Reverse 1/3 Sizes)
Vertical Pin Assemblies**

**R/3 ac Row
Press Fit**

Ordering Information

	Number of Pin	Class 2	Class 3	Option
	20	N85201	N85201-3	
	10	N85203	N85203-3	2,4,6...32 5.08mm Pitch

**R/3 abc Row
Press Fit**

Ordering Information

	Number of Pin	Class 2	Class 3	Option
	30	N85202	N85202-3	
	15	N85204	N85204-3	2,4,6...32 5.08mm Pitch

Press Fit Long Tail 13mm

Ordering Information

	Number of Pin	Class 2	Class 3	Option
	20	N85401	N85401-3	
	10	N85403	N85403-3	2,4,6...32 5.08mm Pitch

Press Fit Long Tail 13mm

Ordering Information

	Number of Pin	Class 2	Class 3	Option
	30	N85042	N85042-3	
	15	N85404	N85404-3	2,4,6...32 5.08mm Pitch

Press Fit Long Tail 13mm

Full Gold Plating

Ordering Information

	Number of Pin	Class 2	Class 3	Option
	20	N85601	N85601-3	
	10	N85603	N85603-3	2,4,6...32 5.08mm Pitch

Press Fit Long Tail 13mm

Full Gold Plating

Ordering Information

	Number of Pin	Class 2	Class 3	Option
	30	N85602	N85602-3	
	15	N85604	N85604-3	2,4,6...32 5.08mm Pitch

Eurocard Connectors 2.54mm Pitch

Type R120 (Reverse Extend Sizes)
Right Angle Receptacle Assemblies

R Extend ac Row

Soldering

Ordering Information

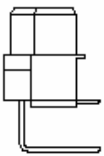
	Number of Pin	Class 2	Class 3	Option
	80	N86101	N86101-3	
	40	N86103	N86103-3	2,4,6...32 5.08mm Pitch

R Extend abc Row

Soldering

Ordering Information

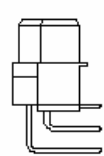
	Number of Pin	Class 2	Class 3	Option
	120	N86102	N86102-3	
	60	N86104	N86104-3	2,4,6...32 5.08mm Pitch

Soldering with clips

Ordering Information

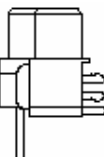
	Number of Pin	Class 2	Class 3	Option
	80	N86111	N86111-3	
	40	N86113	N86113-3	2,4,6...32 5.08mm Pitch

Soldering with clips

Ordering Information

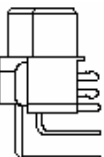
	Number of Pin	Class 2	Class 3	Option
	120	N86112	N86112-3	
	60	N86114	N86114-3	2,4,6...32 5.08mm Pitch

R Extend ac Row

Press-fit

Ordering Information

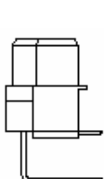
	Number of Pin	Class 2	Class 3	
	80	N86201	N86201-3	
	40	N86203	N86203-3	2,4,6...32 5.08mm Pitch
	Available upon request			

R Extend abc Row

Press-fit

Ordering Information

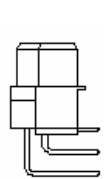
	Number of Pin	Class 2	Class 3	
	120	N86202	N86202-3	
	60	N86204	N86204-3	2,4,6...32 5.08mm Pitch
	Available upon request			

Eurocard Connectors 2.54mm Pitch

Type R120 (Reverse Extend Sizes)
Vertical Pin Assemblies

Material

Housing - Polyester, grey

Contacts - Copper Alloy

DIN Class 2 Plating - 15u" Gold Plating on Mating

Area. Tin Plating on Tail Area.

Nickel Underplate Allover

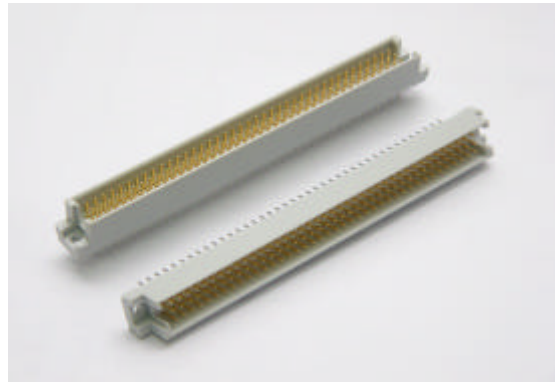

All dimensions in mm

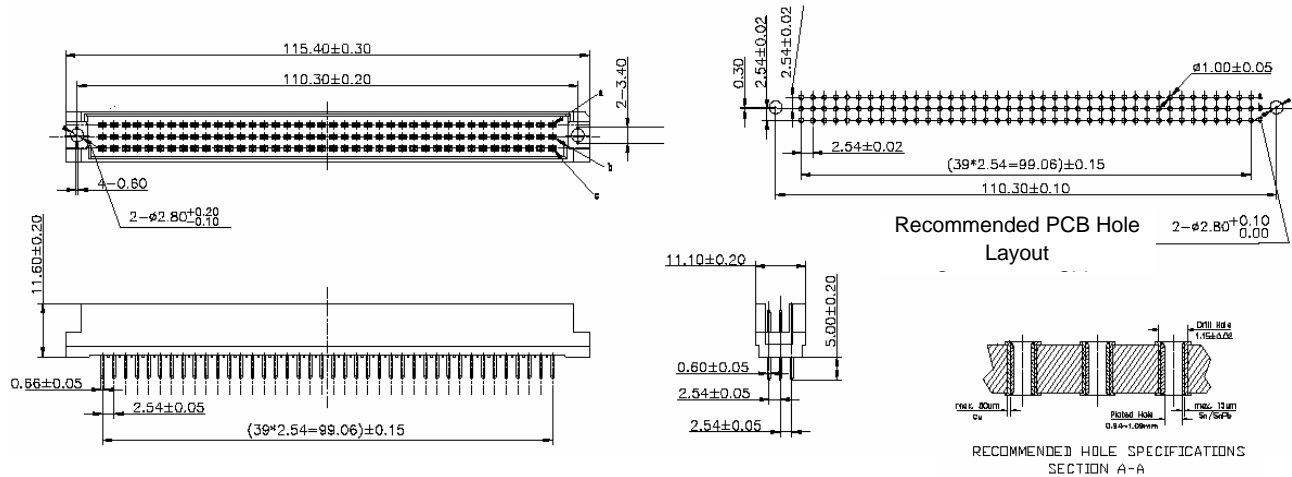

How to order

Part Number Information		I	II	III	IV - VI	VII
		N	8	7	xxx	-X
I	N - DIN 41612 Connectors					
II	1 - Type B		2 - Type C			
	3 - Type D		4 - Type E			
	5 - Type F		6 - Type H			
	7 - Type Q		8 - Type R			
	9 - Type M		0 - Accessories			
III	0 - Female		1 - Male			
	2 - 1/2 Sizes Female (R/2)		3 - 1/2 Sizes Male (R/2)			
	4 - 1/3 Size Female (R/3)		5 - 1/3 Size Male (R/3)			
	6 - Extend Size Female		7 - Extend Size Male			
	8 -		9 - Guide frame			
IV	xxx	Please Consult to Sales Representative to Fix the Optional				
VII	X	1- Class 1	3-Class 3	Omit-Class 2		

Eurocard Connectors 2.54mm Pitch

Type R120 (Reverse Extend Sizes)

Vertical Pin Assemblies

R Extend ac Row

Soldering

Ordering Information

	Number of Pin	Class 2	Class 3	Option
	80	N87103	N87103-3	
	40	N87104	N87104-3	2,4,6...32 5.08mm Pitch

R Extend abc Row

Soldering

Ordering Information

	Number of Pin	Class 2	Class 3	Option
	120	N87101	N87101-3	
	60	N87102	N87102-3	2,4,6...32 5.08mm Pitch

Soldering Long Tail 13mm

Ordering Information

	Number of Pin	Class 2	Class 3	Option
	80	N87303	N87303-3	
	40	N87304	N87304-3	2,4,6...32 5.08mm Pitch

Soldering Long Tail 13mm

Ordering Information

	Number of Pin	Class 2	Class 3	Option
	120	N87301	N87301-3	
	60	N87302	N87302-3	2,4,6...32 5.08mm Pitch

Soldering Long Tail 13mm

Full Gold Plating

Ordering Information

	Number of Pin	Class 2	Class 3	Option
	80	N87503	N87503-3	
	40	N87504	N87504-3	2,4,6...32 5.08mm Pitch

Soldering Long Tail 13mm

Full Gold Plating

Ordering Information

	Number of Pin	Class 2	Class 3	Option
	120	N87501	N87501-3	
	60	N87502	N87502-3	2,4,6...32 5.08mm Pitch

Eurocard Connectors 2.54mm Pitch

**Type R120 (Reverse Extend Sizes)
Vertical Pin Assemblies**

**R Extend ac Row
Press Fit**

Ordering Information

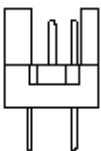
	Number of Pin	Class 2	Class 3	Option
	80	N87203	N87203-3	
	40	N87204	N87204-3	2,4,6...32 5.08mm Pitch

**R Extend abc Row
Press Fit**

Ordering Information

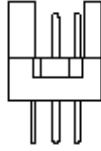
	Number of Pin	Class 2	Class 3	Option
	120	N87201	N87201-3	
	60	N87202	N87202-3	2,4,6...32 5.08mm Pitch

Press Fit Long Tail 13mm

Ordering Information

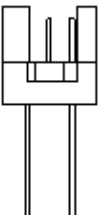
	Number of Pin	Class 2	Class 3	Option
	80	N87403	N87403-3	
	40	N87404	N87404-3	2,4,6...32 5.08mm Pitch

Press Fit Long Tail 13mm

Ordering Information

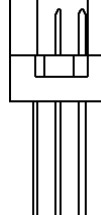
	Number of Pin	Class 2	Class 3	Option
	120	N87401	N87401-3	
	60	N87402	N87402-3	2,4,6...32 5.08mm Pitch

Press Fit Long Tail 13mm

Full Gold Plating

Ordering Information

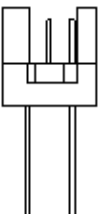
	Number of Pin	Class 2	Class 3	Option
	80	N87603	N87603-3	
	40	N87604	N87604-3	2,4,6...32 5.08mm Pitch

Press Fit Long Tail 13mm

Full Gold Plating

Ordering Information

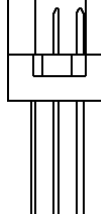
	Number of Pin	Class 2	Class 3	Option
	120	N87601	N87601-3	
	60	N87602	N87602-3	2,4,6...32 5.08mm Pitch