

Eurocard Connectors 2.54mm Pitch

Type C
Vertical Receptacle Assemblies

Material

Housing - Polyester, grey

Contacts - Copper Alloy

DIN Class 2 Plating - 15u" Gold Plating on Mating Area. Tin Plating on Tail Area.

Nickel Underplate Allover

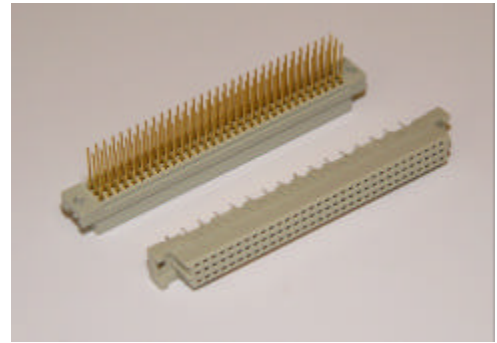

All dimensions in mm

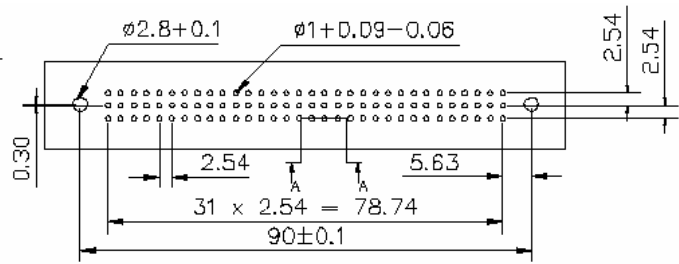
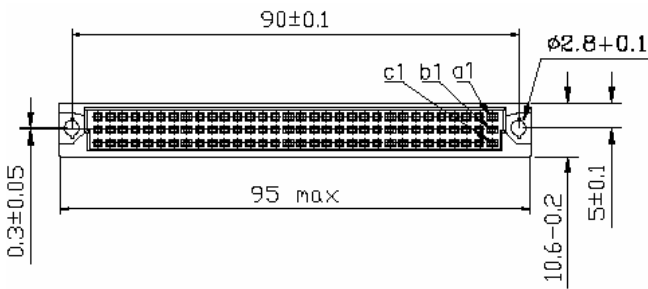

Recommended PCB Hole Layout

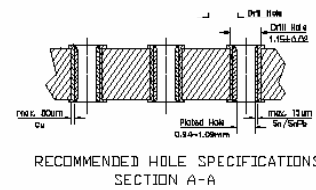
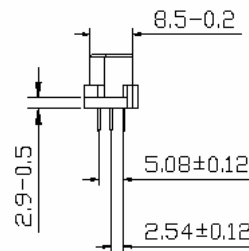
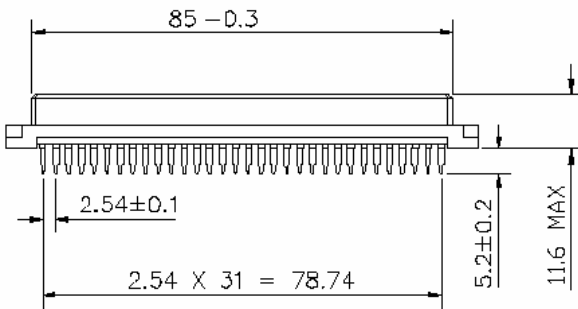

How to order

Part Number Information	I	II	III	IV - VI	VII
	N	2	0	xxx	-X
I	N - DIN 41612 Connectors				
II	1 - Type B	2 - Type C			
	3 - Type D	4 - Type E			
	5 - Type F	6 - Type H			
	7 - Type Q	8 - Type R			
	9 - Type M	0 - Accessories			
III	0 - Female	1 - Male			
	2 - 1/2 Sizes Female (C/2)	3 - 1/2 Sizes Male (C/2)			
	4 - 1/3 Size Female (C/3)	5 - 1/3 Size Male (C/3)			
	6 - Extend Size Female	7 - Extend Size Male			
	8 -	9 - Guide frame			
IV	xxx	Please Consult to Sales Representative to Fix the Optional			
VII	X	1- Class 1	3-Class 3	Omit-Class 2	

Eurocard Connectors 2.54mm Pitch

Type C

Vertical Receptacle Assemblies

**C ac Row
Soldering**

Ordering Information

	Number of Pin	Class 2	Class 3	Option
	64	N20101	N20101-3	
	32	N20103	N20103-3	2,4,6...32 5.08mm Pitch

**C abc Row
Soldering**

Ordering Information

	Number of Pin	Class 2	Class 3	Option
	96	N20102	N20102-3	
	48	N20104	N20104-3	2,4,6...32 5.08mm Pitch

Soldering Long Tail 13mm

Ordering Information

	Number of Pin	Class 2	Class 3	Option
	64	N20111	N20111-3	
	32	N20113	N20113-3	2,4,6...32 5.08mm Pitch

Soldering Long Tail 13mm

Ordering Information

	Number of Pin	Class 2	Class 3	Option
	96	N20112	N20112-3	
	48	N20114	N20114-3	2,4,6...32 5.08mm Pitch

Soldering Long Tail 13mm

Full Gold Plating

Ordering Information

	Number of Pin	Class 2	Class 3	Option
	64	N20501	N20501-3	
	32	N20503	N20503-3	2,4,6...32 5.08mm Pitch

Soldering Long Tail 13mm

Full Gold Plating

Ordering Information

	Number of Pin	Class 2	Class 3	Option
	96	N20502	N20502-3	
	48	N20504	N20504-3	2,4,6...32 5.08mm Pitch

Type C

Vertical Receptacle Assemblies

C ac Row

Press Fit

Ordering Information

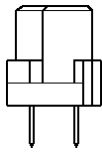
	Number of Pin	Class 2	Class 3	Option
	64	N20201	N20201-3	
	32	N20203	N20203-3	2,4,6...32 5.08mm Pitch

C abc Row

Press Fit

Ordering Information

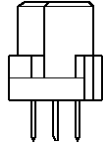
	Number of Pin	Class 2	Class 3	Option
	96	N20202	N20202-3	
	48	N20204	N20204-3	2,4,6...32 5.08mm Pitch

Press Fit Long Tail 13mm

Ordering Information

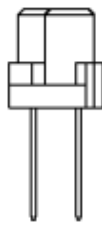
	Number of Pin	Class 2	Class 3	Option
	64	N20401	N20401-3	
	32	N20403	N20403-3	2,4,6...32 5.08mm Pitch

Press Fit Long Tail 13mm

Ordering Information

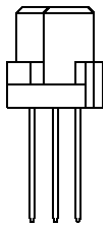
	Number of Pin	Class 2	Class 3	Option
	96	N20402	N20402-3	
	48	N20404	N20404-3	2,4,6...32 5.08mm Pitch

Press Fit Long Tail 13mm

Full Gold Plating

Ordering Information

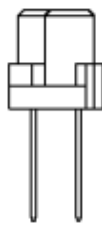
	Number of Pin	Class 2	Class 3	Option
	64	N20601	N20601-3	
	32	N20603	N20603-3	2,4,6...32 5.08mm Pitch

Press Fit Long Tail 13mm

Full Gold Plating

Ordering Information

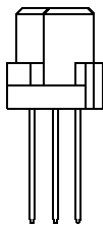
	Number of Pin	Class 2	Class 3	Option
	96	N20602	N20602-3	
	48	N20604	N20604-3	2,4,6...32 5.08mm Pitch

Eurocard Connectors 2.54mm Pitch

Type C

Right Angle Pin Assemblies

Material

Housing - Polyester, grey

Contacts - Copper Alloy

DIN Class 2 Plating - 15u" Gold Plating on Mating

Area. Tin Plating on Tail Area.

Nickel Underplate Allover

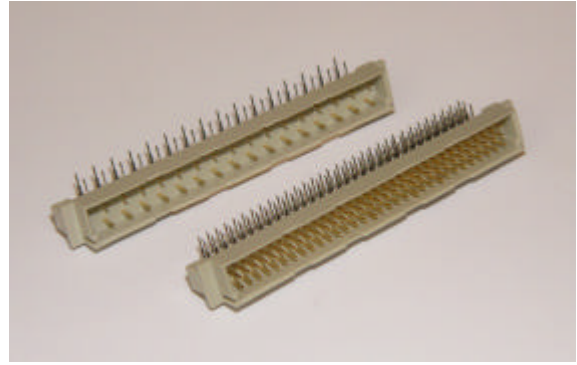

All dimensions in mm

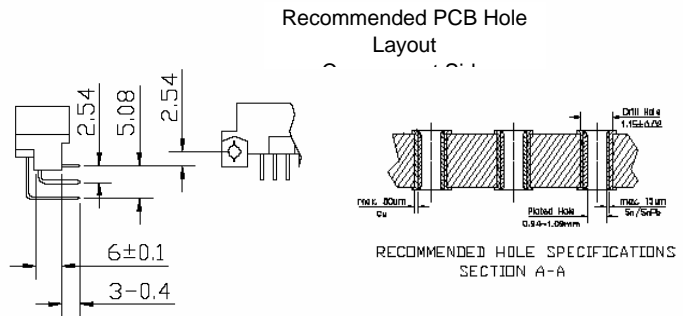
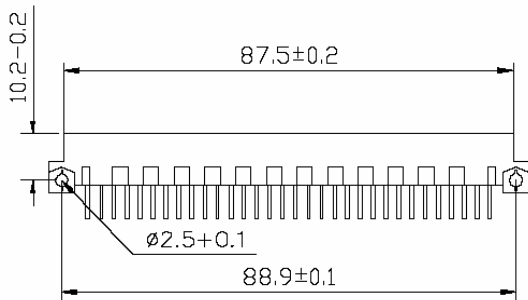
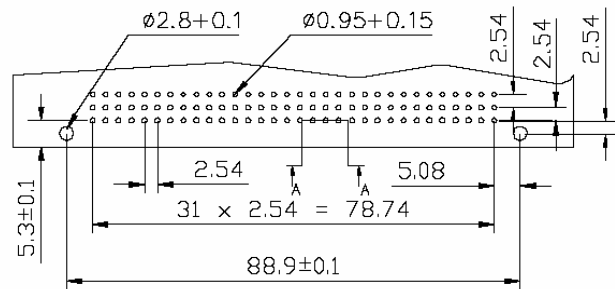
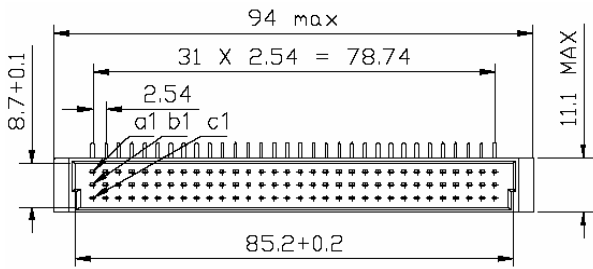

How to order

Part Number Information	I	II	III	IV - VI	VII
	N	2	1	xxx	-X
I	N - DIN 41612 Connectors				
II	1 - Type B	2 - Type C			
	3 - Type D	4 - Type E			
	5 - Type F	6 - Type H			
	7 - Type Q	8 - Type R			
	9 - Type M	0 - Accessories			
III	0 - Female	1 - Male			
	2 - 1/2 Sizes Female (C/2)	3 - 1/2 Sizes Male (C/2)			
	4 - 1/3 Size Female (C/3)	5 - 1/3 Size Male (C/3)			
	6 - Extend Size Female	7 - Extend Size Male			
	8 -	9 - Guide frame			
IV	xxx	Please Consult to Sales Representative to Fix the Optional			
VII	X	1- Class 1	3-Class 3	Omit-Class 2	

Eurocard Connectors 2.54mm Pitch

**Type C
Right Angle Pin Assemblies**

**C ac Row
Soldering**

Ordering Information

	Number of Pin	Class 2	Class 3	Option
	64	N21101	N21101-3	
	32	N21103	N21103-3	2,4,6...32 5.08mm Pitch

**C abc Row
Soldering**

Ordering Information

	Number of Pin	Class 2	Class 3	Option
	96	N21102	N21102-3	
	48	N21104	N21104-3	2,4,6...32 5.08mm Pitch

Soldering with clips

Ordering Information

	Number of Pin	Class 2	Class 3	Option
	64	N21301	N21301-3	
	32	N21303	N21303-3	2,4,6...32 5.08mm Pitch

Soldering with clips

Ordering Information

	Number of Pin	Class 2	Class 3	Option
	96	N21302	N21302-3	
	48	N21304	N21304-3	2,4,6...32 5.08mm Pitch

**C ac Row
Press-fit**

Ordering Information

	Number of Pin	Class 2	Class 3	Option
	64	N21501	N21501-3	
	32	N21503	N21503-3	2,4,6...32 5.08mm Pitch
Available upon request				

**C abc Row
Press-fit**

Ordering Information

	Number of Pin	Class 2	Class 3	Option
	96	N21502	N21502-3	
	48	N21504	N21504-3	2,4,6...32 5.08mm Pitch
Available upon request				

Eurocard Connectors 2.54mm Pitch

Type C/2 (Half Sizes)

Vertical Receptacle Assemblies

Material

Housing - Polyester, grey

Contacts - Copper Alloy

DIN Class 2 Plating - 15u" Gold Plating on Mating

Area. Tin Plating on Tail Area.

Nickel Underplate Allover

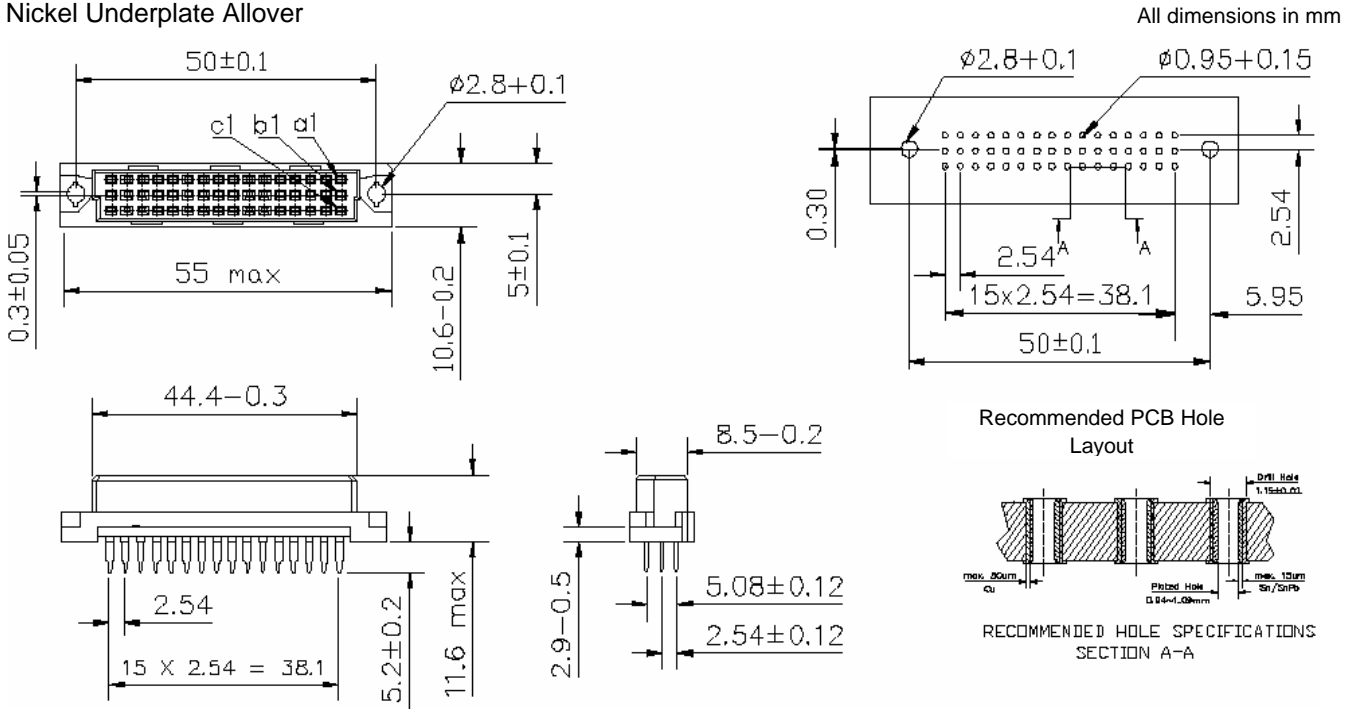
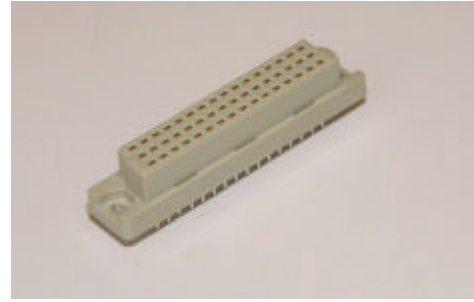

How to order

Part Number Information	I	II	III	IV - VI	VII
	N	2	2	xxx	-X
I	N - DIN 41612 Connectors				
II	1 - Type B	2 - Type C			
	3 - Type D	4 - Type E			
	5 - Type F	6 - Type H			
	7 - Type Q	8 - Type R			
	9 - Type M	0 - Accessories			
III	0 - Female	1 - Male			
	2 - 1/2 Sizes Female (C/2)	3 - 1/2 Sizes Male (C/2)			
	4 - 1/3 Size Female (C/3)	5 - 1/3 Size Male (C/3)			
	6 - Extend Size Female	7 - Extend Size Male			
	8 -	9 - Guide frame			
IV	xxx	Please Consult to Sales Representative to Fix the Optional			
VII	X	1- Class 1	3-Class 3	Omit-Class 2	

Eurocard Connectors 2.54mm Pitch

**Type C/2 (Half Sizes)
Vertical Receptacle Assemblies**

**C/2 ac Row
Soldering**

Ordering Information

	Number of Pin	Class 2	Class 3	Option
	32	N22101	N22101-3	
	16	N22103	N22103-3	2,4,6...32 5.08mm Pitch

**C/2 abc Row
Soldering**

Ordering Information

	Number of Pin	Class 2	Class 3	Option
	48	N22102	N22102-3	
	24	N22104	N22104-3	2,4,6...32 5.08mm Pitch

Soldering Long Tail 13mm

Ordering Information

	Number of Pin	Class 2	Class 3	Option
	32	N22111	N22111-3	
	16	N22113	N22113-3	2,4,6...32 5.08mm Pitch

Soldering Long Tail 13mm

Ordering Information

	Number of Pin	Class 2	Class 3	Option
	48	N22112	N22112-3	
	24	N22114	N22114-3	2,4,6...32 5.08mm Pitch

Soldering Long Tail 13mm

Full Gold Plating

Ordering Information

	Number of Pin	Class 2	Class 3	Option
	32	N22501	N22501-3	
	16	N22503	N22503-3	2,4,6...32 5.08mm Pitch

Soldering Long Tail 13mm

Full Gold Plating

Ordering Information

	Number of Pin	Class 2	Class 3	Option
	48	N22502	N22502-3	
	24	N22504	N22504-3	2,4,6...32 5.08mm Pitch

Eurocard Connectors 2.54mm Pitch

Type C/2 (Half Sizes)

Vertical Receptacle Assemblies

C/2 ac Row

Press Fit

Ordering Information

	Number of Pin	Class 2	Class 3	Option
	32	N22201	N22201-3	
	16	N22203	N22203-3	2,4,6...32 5.08mm Pitch

C/2 abc Row

Press Fit

Ordering Information

	Number of Pin	Class 2	Class 3	Option
	48	N22202	N22202-3	
	24	N22204	N22204-3	2,4,6...32 5.08mm Pitch

Press Fit Long Tail 13mm

Ordering Information

	Number of Pin	Class 2	Class 3	Option
	32	N22401	N22401-3	
	16	N22403	N22403-3	2,4,6...32 5.08mm Pitch

Press Fit Long Tail 13mm

Ordering Information

	Number of Pin	Class 2	Class 3	Option
	48	N22402	N22402-3	
	24	N22404	N22404-3	2,4,6...32 5.08mm Pitch

Press Fit Long Tail 13mm

Full Gold Plating

Ordering Information

	Number of Pin	Class 2	Class 3	Option
	32	N22601	N22601-3	
	16	N22603	N22603-3	2,4,6...32 5.08mm Pitch

Press Fit Long Tail 13mm

Full Gold Plating

Ordering Information

	Number of Pin	Class 2	Class 3	Option
	48	N22602	N22602-3	
	24	N22604	N22604-3	2,4,6...32 5.08mm Pitch

Type C/2 (Half Sizes)

Right Angle Pin Assemblies

Material

Housing - Polyester, grey

Contacts - Copper Alloy

DIN Class 2 Plating - 15u" Gold Plating on Mating Area. Tin Plating on Tail Area.

Nickel Underplate Allover



All dimensions in mm

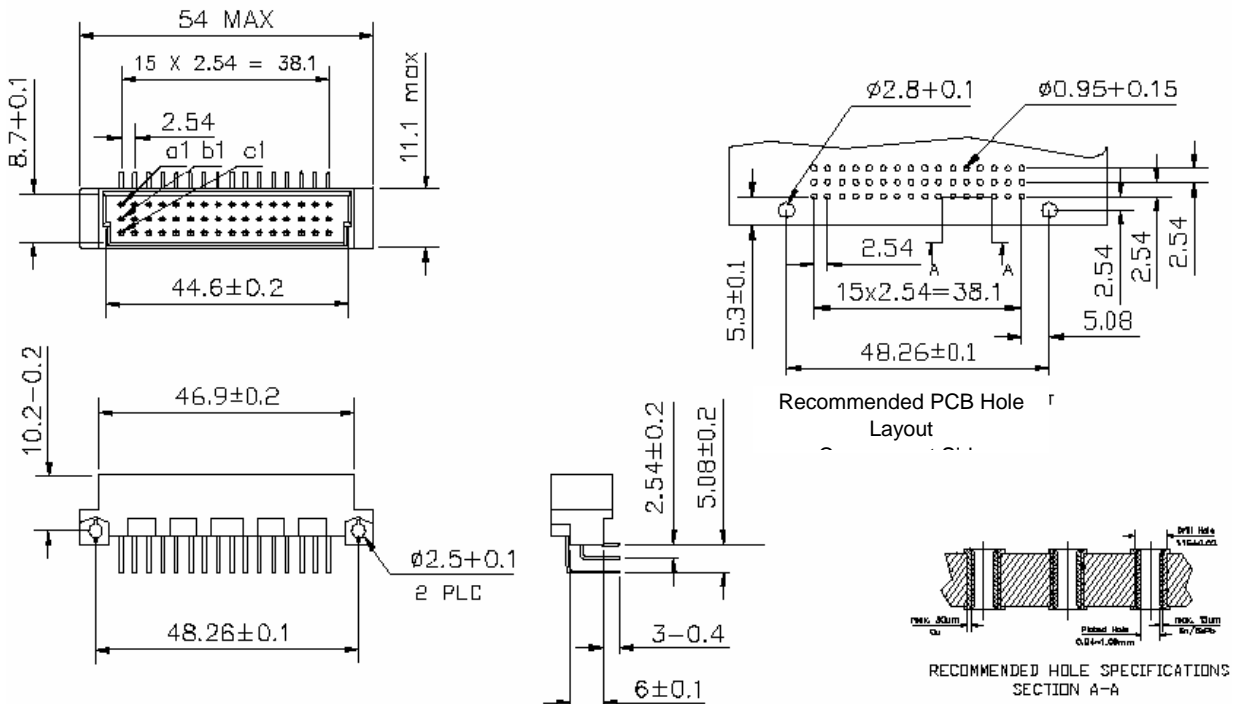

How to order

Part Number Information	I	II	III	IV - VI	VII
	N	2	3	xxx	-X
I	N - DIN 41612 Connectors				
II	1 - Type B	2 - Type C			
	3 - Type D	4 - Type E			
	5 - Type F	6 - Type H			
	7 - Type Q	8 - Type R			
	9 - Type M	0 - Accessories			
III	0 - Female	1 - Male			
	2 - 1/2 Sizes Female (C/2)	3 - 1/2 Sizes Male (C/2)			
	4 - 1/3 Size Female (C/3)	5 - 1/3 Size Male (C/3)			
	6 - Extend Size Female	7 - Extend Size Male			
	8 -	9 - Guide frame			
IV	xxx	Please Consult to Sales Representative to Fix the Optional			
VII	X	1- Class 1	3-Class 3	Omit-Class 2	

Eurocard Connectors 2.54mm Pitch

Type C/2 (Half Sizes)

Right Angle Pin Assemblies

**C/2 ac Row
Soldering**

Ordering Information

	Number of Pin	Class 2	Class 3	Option
	32	N23101	N23101-3	
	16	N23103	N23103-3	2,4,6...32 5.08mm Pitch

**C/2 abc Row
Soldering**

Ordering Information

	Number of Pin	Class 2	Class 3	Option
	48	N23102	N23102-3	
	24	N23104	N23104-3	2,4,6...32 5.08mm Pitch

Soldering with clips

Ordering Information

	Number of Pin	Class 2	Class 3	Option
	32	N23301	N23301-3	
	16	N23303	N23303-3	2,4,6...32 5.08mm Pitch

Soldering with clips

Ordering Information

	Number of Pin	Class 2	Class 3	Option
	48	N23302	N23302-3	
	24	N23304	N23304-3	2,4,6...32 5.08mm Pitch

**C/2 ac Row
Press-fit**

Ordering Information

	Number of Pin	Class 2	Class 3	Option
	32	N23501	N23501-3	
	16	N23503	N23503-3	2,4,6...32 5.08mm Pitch
Available upon request				

**C/2 abc Row
Press-fit**

Ordering Information

	Number of Pin	Class 2	Class 3	Option
	48	N23502	N23502-3	
	24	N23504	N23504-3	2,4,6...32 5.08mm Pitch
Available upon request				

Eurocard Connectors 2.54mm Pitch

Type C/3 (1/3 Sizes)

Vertical Receptacle Assemblies

Material

Housing - Polyester, grey

Contacts - Copper Alloy

DIN Class 2 Plating - 15u" Gold Plating on Mating Area. Tin Plating on Tail Area.

Nickel Underplate Allover

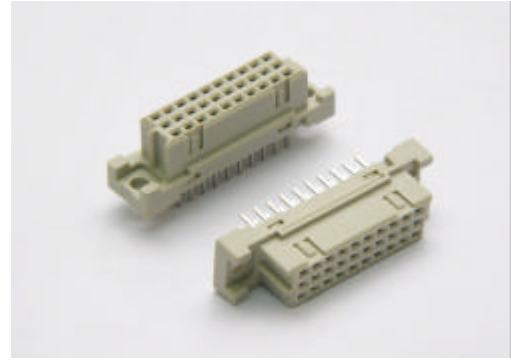

All dimensions in mm

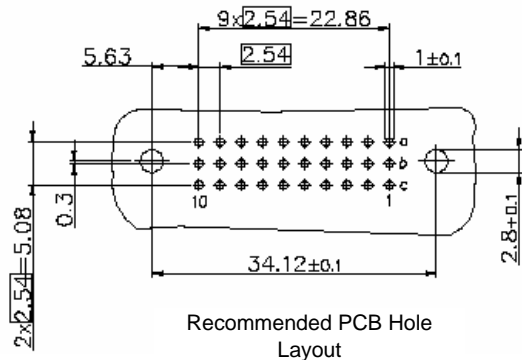
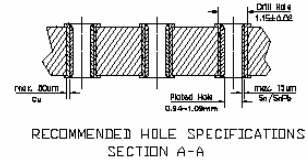
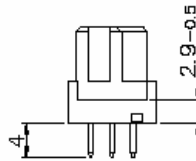
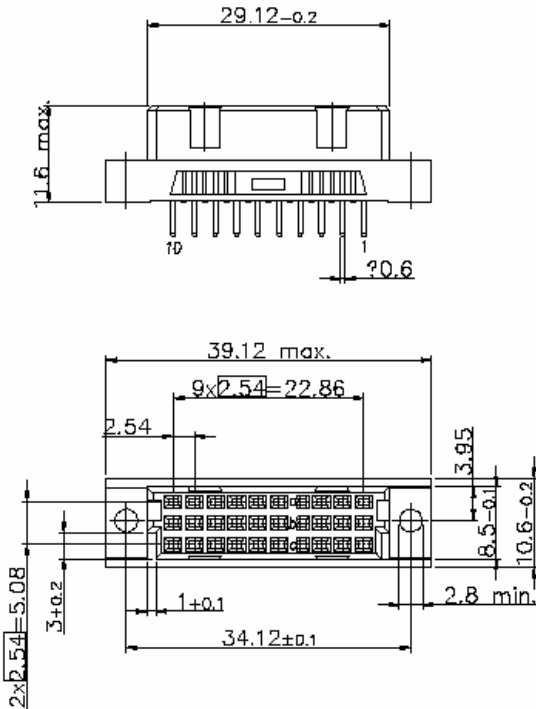

How to order

Part Number Information		I	II	III	IV - VI	VII
		N	2	4	xxx	-X
I	N - DIN 41612 Connectors					
II	1 - Type B	2 - Type C				
	3 - Type D	4 - Type E				
	5 - Type F	6 - Type H				
	7 - Type Q	8 - Type R				
	9 - Type M	0 - Accessories				
III	0 - Female	1 - Male				
	2 - 1/2 Sizes Female (C/2)	3 - 1/2 Sizes Male (C/2)				
	4 - 1/3 Size Female (C/3)	5 - 1/3 Size Male (C/3)				
	6 - Extend Size Female	7 - Extend Size Male				
	8 -	9 - Guide frame				
IV	xxx	Please Consult to Sales Representative to Fix the Optional				
VII	X	1- Class 1	3-Class 3	Omit-Class 2		

Eurocard Connectors 2.54mm Pitch

Type C/3 (1/3 Sizes)

Vertical Receptacle Assemblies

**C/3 ac Row
Soldering**

Ordering Information

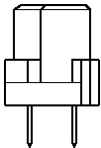
	Number of Pin	Class 2	Class 3	Option
	20	N24101	N24101-3	
	10	N24103	N24103-3	2,4,6...32 5.08mm Pitch

**C/3 abc Row
Soldering**

Ordering Information

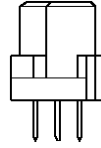
	Number of Pin	Class 2	Class 3	Option
	30	N24102	N24102-3	
	15	N24104	N24104-3	2,4,6...32 5.08mm Pitch

Soldering Long Tail 13mm

Ordering Information

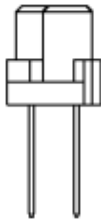
	Number of Pin	Class 2	Class 3	Option
	20	N24111	N24111-3	
	10	N24113	N24113-3	2,4,6...32 5.08mm Pitch

Soldering Long Tail 13mm

Ordering Information

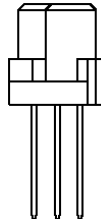
	Number of Pin	Class 2	Class 3	Option
	30	N24112	N24112-3	
	15	N24114	N24114-3	2,4,6...32 5.08mm Pitch

Soldering Long Tail 13mm

Full Gold Plating

Ordering Information

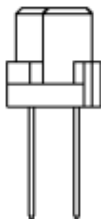
	Number of Pin	Class 2	Class 3	Option
	20	N24501	N24501-3	
	10	N24503	N24503-3	2,4,6...32 5.08mm Pitch

Soldering Long Tail 13mm

Full Gold Plating

Ordering Information

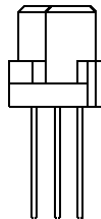
	Number of Pin	Class 2	Class 3	Option
	30	N24502	N24502-3	
	15	N24504	N24504-3	2,4,6...32 5.08mm Pitch

Type C/3 (1/3 Sizes)

Vertical Receptacle Assemblies

C/3 ac Row

Press Fit

Ordering Information

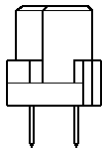
	Number of Pin	Class 2	Class 3	Option
	20	N24201	N24201-3	
	10	N24203	N24203-3	2,4,6...32 5.08mm Pitch

C/3 abc Row

Press Fit

Ordering Information

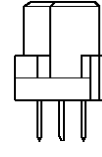
	Number of Pin	Class 2	Class 3	Option
	30	N24202	N24202-3	
	15	N24204	N24204-3	2,4,6...32 5.08mm Pitch

Press Fit Long Tail 13mm

Ordering Information

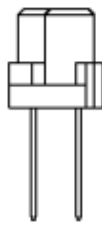
	Number of Pin	Class 2	Class 3	Option
	20	N24401	N24401-3	
	10	N24403	N24403-3	2,4,6...32 5.08mm Pitch

Press Fit Long Tail 13mm

Ordering Information

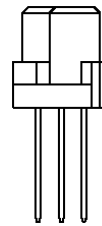
	Number of Pin	Class 2	Class 3	Option
	30	N24402	N24402-3	
	15	N24404	N24404-3	2,4,6...32 5.08mm Pitch

Press Fit Long Tail 13mm

Full Gold Plating

Ordering Information

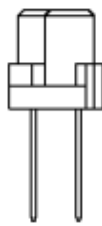
	Number of Pin	Class 2	Class 3	Option
	20	N24601	N24601-3	
	10	N24603	N24603-3	2,4,6...32 5.08mm Pitch

Press Fit Long Tail 13mm

Full Gold Plating

Ordering Information

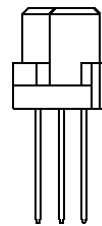
	Number of Pin	Class 2	Class 3	Option
	30	N24602	N24602-3	
	15	N24604	N24604-3	2,4,6...32 5.08mm Pitch

Eurocard Connectors 2.54mm Pitch

Type C/3 (1/3 Sizes)

Right Angle Pin Assemblies

Material

Housing - Polyester, grey

Contacts - Copper Alloy

DIN Class 2 Plating - 15u" Gold Plating on Mating Area. Tin Plating on Tail Area.

Nickel Underplate Allover



All dimensions in mm

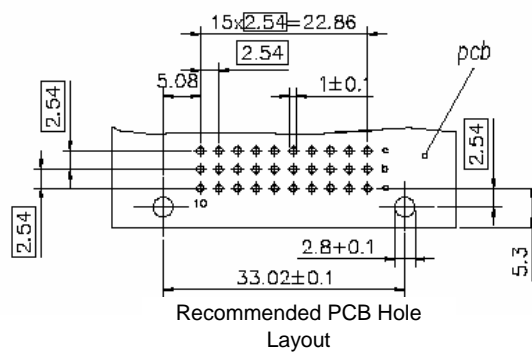
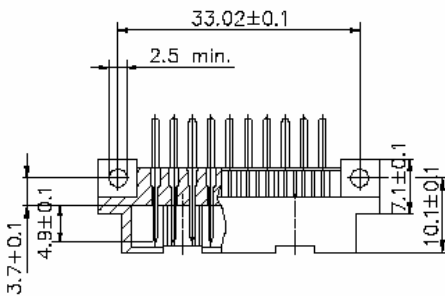
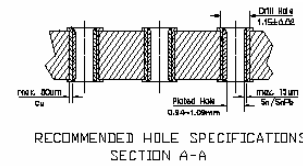
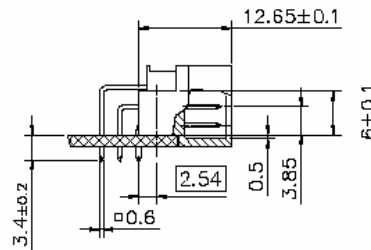
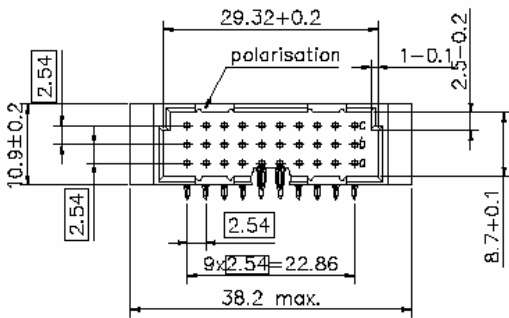

How to order

Part Number Information	I	II	III	IV - VI	VII
	N	2	5	xxx	-X
I	N - DIN 41612 Connectors				
II	1 - Type B	2 - Type C			
	3 - Type D	4 - Type E			
	5 - Type F	6 - Type H			
	7 - Type Q	8 - Type R			
	9 - Type M	0 - Accessories			
III	0 - Female	1 - Male			
	2 - 1/2 Sizes Female (C/2)	3 - 1/2 Sizes Male (C/2)			
	4 - 1/3 Size Female (C/3)	5 - 1/3 Size Male (C/3)			
	6 - Extend Size Female	7 - Extend Size Male			
	8 -	9 - Guide frame			
IV	xxx	Please Consult to Sales Representative to Fix the Optional			
VII	X	1-Class 1	3-Class 3	Omit-Class 2	

Type C/3 (1/3 Sizes)

Right Angle Pin Assemblies

C/3 ac Row

Soldering

Ordering Information

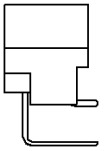
	Number of Pin	Class 2	Class 3	Option
	20	N25101	N25101-3	
	10	N25103	N25103-3	2,4,6...32 5.08mm Pitch

C/3 abc Row

Soldering

Ordering Information

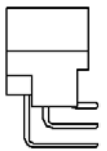
	Number of Pin	Class 2	Class 3	Option
	30	N25102	N25102-3	
	15	N25104	N25104-3	2,4,6...32 5.08mm Pitch

Soldering with clips

Ordering Information

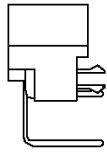
	Number of Pin	Class 2	Class 3	Option
	20	N25301	N25301-3	
	10	N25303	N25303-3	2,4,6...32 5.08mm Pitch

Soldering with clips

Ordering Information

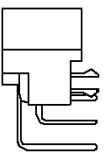
	Number of Pin	Class 2	Class 3	Option
	30	N25302	N25302-3	
	15	N25304	N25304-3	2,4,6...32 5.08mm Pitch

C/3 ac Row

Press-fit

Ordering Information

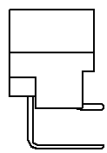
	Number of Pin	Class 2	Class 3	Option
	20	N25501	N25501-3	
	10	N25503	N25503-3	2,4,6...32 5.08mm Pitch
Available upon request				

C/3 abc Row

Press-fit

Ordering Information

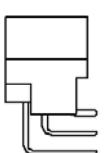
	Number of Pin	Class 2	Class 3	Option
	30	N25502	N25502-3	
	15	N25504	N25504-3	2,4,6...32 5.08mm Pitch
Available upon request				