

Eurocard Connectors 2.54mm Pitch

Type B
Vertical Receptacle Assemblies

Material

Housing - Polyester, grey

Contacts - Copper Alloy

DIN Class 2 Plating - 15u" Gold Plating on Mating Area. Tin Plating on Tail Area.

Nickel Underplate Allover



All dimensions in mm

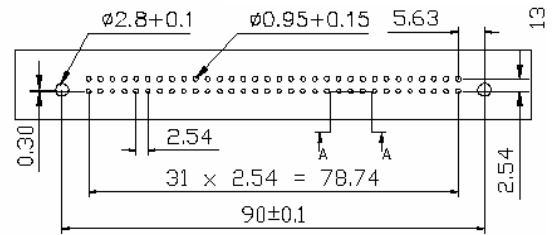
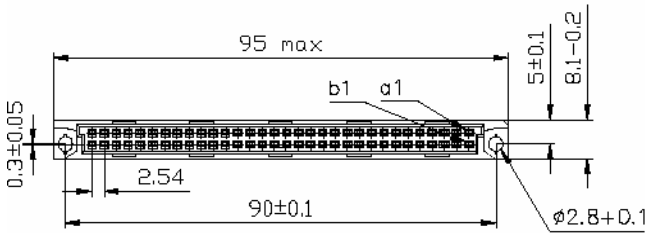

Recommended PCB Hole Layout

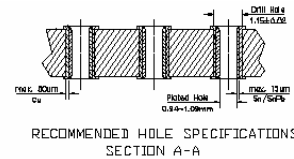
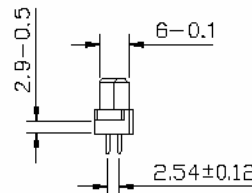
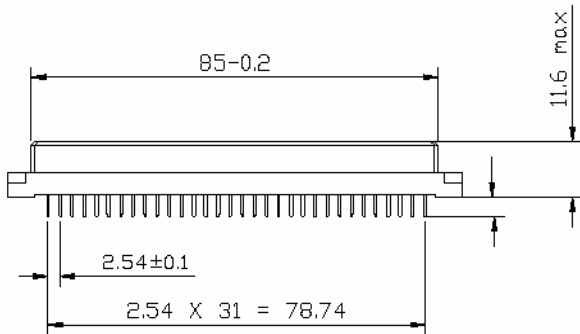

RECOMMENDED HOLE SPECIFICATIONS SECTION A-A

How to order

Part Number Information		I	II	III	IV - VI	VII
		N	1	0	xxx	-X
I	N - DIN 41612 Connectors					
	1 - Type B	2 - Type C				
	3 - Type D	4 - Type E				
	5 - Type F	6 - Type H				
II	7 - Type Q	8 - Type R				
	9 - Type M	0 - Accessories				
III	0 - Female	1 - Male				
	2 - 1/2 Sizes Female (B/2)	3 - 1/2 Sizes Male (B/2)				
	4 - 1/3 Size Female (B/3)	5 - 1/3 Size Male (B/3)				
	6 - Extend Size Female	7 - Extend Size Male				
	8 -	9 - Guide frame				
IV	xxx	Please Consult to Sales Representative to Fix the Optional				
VII	X	1 - Class 1	3 - Class 3	Omit - Class 2		

Eurocard Connectors 2.54mm Pitch

Type B

Vertical Receptacle Assemblies

**B ab Row
Soldering**

Ordering Information

	Number of Pin	Class 2	Class 3	Option
	64	N10101	N10101-3	
	32	N10103	N10103-3	2,4,6...32 5.08mm Pitch

**B ab Row
Press fit**

Ordering Information

	Number of Pin	Class 2	Class 3	Option
	64	N10201	N10201-3	
	32	N10203	N10203-3	2,4,6...32 5.08mm Pitch

Soldering

Long Tail 13mm

Ordering Information

	Number of Pin	Class 2	Class 3	Option
	64	N10301	N10301-3	
	32	N10303	N10303-3	2,4,6...32 5.08mm Pitch

Press fit

Long Tail 13mm

Ordering Information

	Number of Pin	Class 2	Class 3	Option
	64	N10401	N10401-3	
	32	N10403	N10403-3	2,4,6...32 5.08mm Pitch

Soldering

Long Tail 13mm

Full Gold Plating

Ordering Information

	Number of Pin	Class 2	Class 3	Option
	64	N10501	N10501-3	
	32	N10503	N10503-3	2,4,6...32 5.08mm Pitch

Press fit

Long Tail 13mm

Full Gold Plating

Ordering Information

	Number of Pin	Class 2	Class 3	Option
	64	N10601	N10601-3	
	32	N10603	N10603-3	2,4,6...32 5.08mm Pitch

Eurocard Connectors 2.54mm Pitch

Type B
Right Angle Pin Assemblies

Material

Housing - Polyester, grey

Contacts - Copper Alloy

DIN Class 2 Plating - 15u" Gold Plating on Mating Area. Tin Plating on Tail Area.

Nickel Underplate Allover

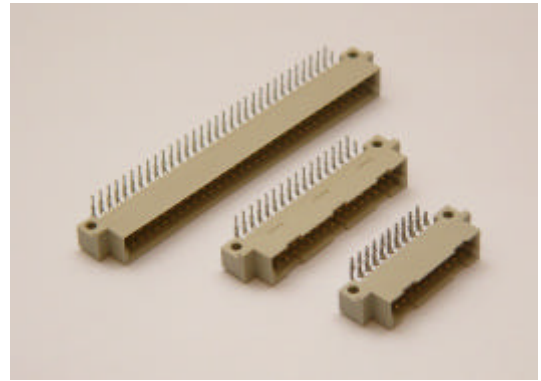

All dimensions in mm

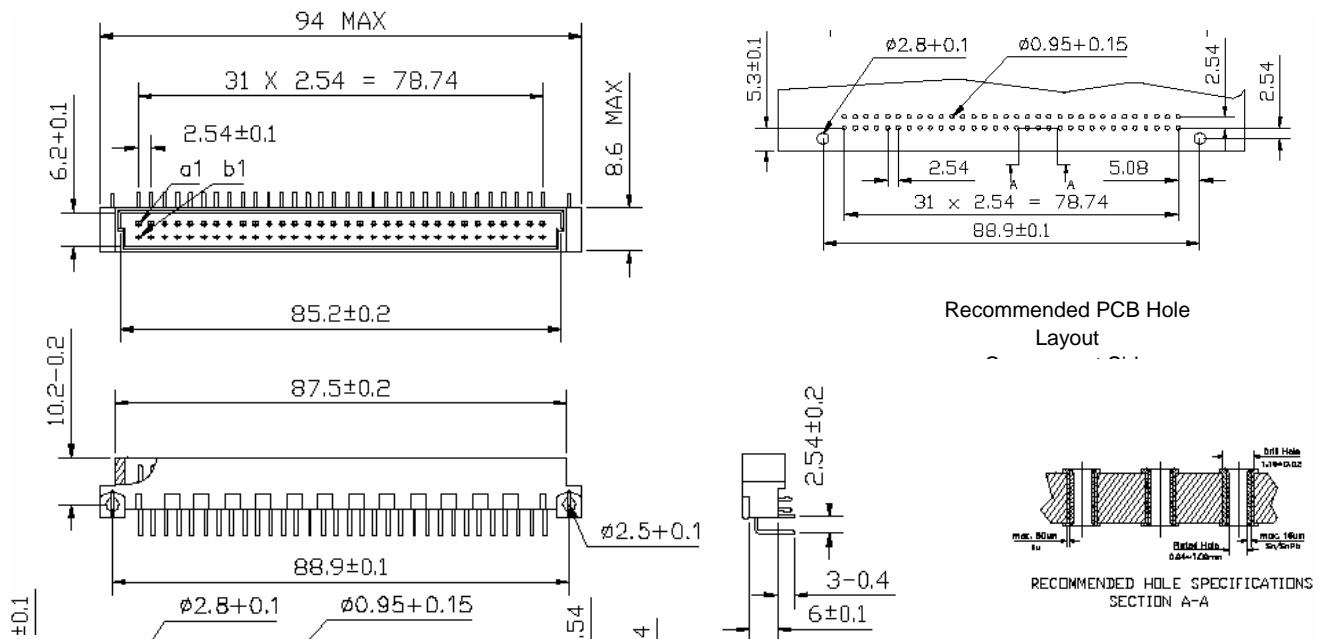

How to order

Part Number Information	I	II	III	IV - VI	VII
	N	1	1	xxx	-X
I	N - DIN 41612 Connectors				
	1 - Type B	2 - Type C			
	3 - Type D	4 - Type E			
II	5 - Type F	6 - Type H			
	7 - Type Q	8 - Type R			
	9 - Type M	0 - Accessories			
III	0 - Female	1 - Male			
	2 - 1/2 Sizes Female (B/2)	3 - 1/2 Sizes Male (B/2)			
	4 - 1/3 Size Female (B/3)	5 - 1/3 Size Male (B/3)			
	6 - Extend Size Female	7 - Extend Size Male			
	8 -	9 - Guide frame			
IV	xxx	Please Consult to Sales Representative to Fix the Optional			
VII	X	1- Class 1	3-Class 3	Omit-Class 2	

Eurocard Connectors 2.54mm Pitch

Type B

Right Angle Pin Assemblies

B ab Row

Soldering

Ordering Information

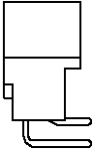
	Number of Pin	Class 2	Class 3	Option
	64	N11101	N11101-3	
	32	N11103	N11103-3	2,4,6...32 5.08mm Pitch

Soldering with clips

Ordering Information

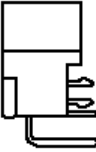
	Number of Pin	Class 2	Class 3	Option
	64	N11301	N11301-3	
	32	N11303	N11303-3	2,4,6...32 5.08mm Pitch

B ab Row

Press-fit

Ordering Information

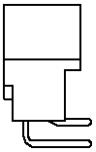
	Number of Pin	Class 2	Class 3	
	64	N11501	N11501-3	
	32	N11503	N11503-3	2,4,6...32 5.08mm Pitch
	Available upon request			

Eurocard Connectors 2.54mm Pitch

Type B/2 (Half Sizes)

Vertical Receptacle Assemblies

Material

Housing - Polyester, grey

Contacts - Copper Alloy

DIN Class 2 Plating - 15u" Gold Plating on Mating Area. Tin Plating on Tail Area.

Nickel Underplate Allover

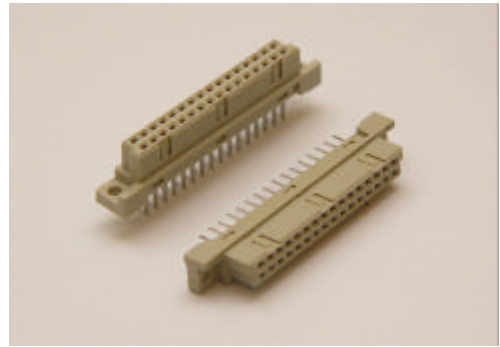

All dimensions in mm

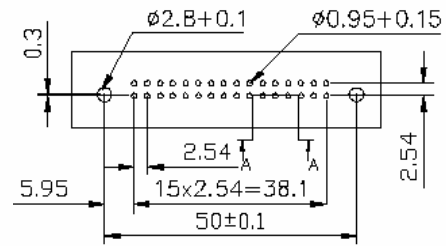
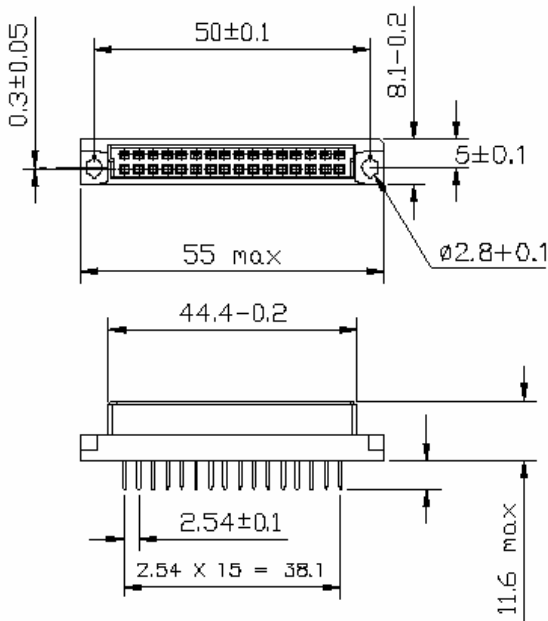

Recommended PCB Hole Layout
Component Side

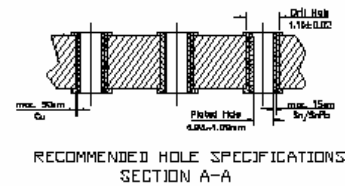
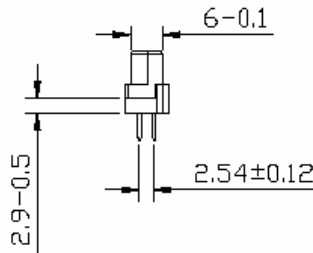

RECOMMENDED HOLE SPECIFICATIONS
SECTION A-A

How to order

Part Number Information	I	II	III	IV - VI	VII
	N	1	2	xxx	-X
I	N - DIN 41612 Connectors				
II	1 - Type B		2 - Type C		
	3 - Type D		4 - Type E		
	5 - Type F		6 - Type H		
	7 - Type Q		8 - Type R		
	9 - Type M		0 - Accessories		
III	0 - Female		1 - Male		
	2 - 1/2 Sizes Female (B/2)		3 - 1/2 Sizes Male (B/2)		
	4 - 1/3 Size Female (B/3)		5 - 1/3 Size Male (B/3)		
	6 - Extend Size Female		7 - Extend Size Male		
	8 -		9 - Guide frame		
IV	xxx	Please Consult to Sales Representative to Fix the Optional			
VII	X	1-Class 1	3-Class 3	Omit-Class 2	

Eurocard Connectors 2.54mm Pitch

Type B/2 (Half Sizes)

Vertical Receptacle Assemblies

B/2 ab Row

Soldering

Ordering Information

	Number of Pin	Class 2	Class 3	Option
	32	N12101	N12101-3	
	16	N12103	N12103-3	2,4,6...32 5.08mm Pitch

B/2 ab Row

Press Fit

Ordering Information

	Number of Pin	Class 2	Class 3	Option
	32	N12201	N12201-3	
	16	N12203	N12203-3	2,4,6...32 5.08mm Pitch

Soldering

Long Tail 13mm

Ordering Information

	Number of Pin	Class 2	Class 3	Option
	32	N12301	N12301-3	
	16	N12303	N12303-3	2,4,6...32 5.08mm Pitch

Press Fit

Long Tail 13mm

Ordering Information

	Number of Pin	Class 2	Class 3	Option
	32	N12401	N12401-3	
	16	N12403	N12403-3	2,4,6...32 5.08mm Pitch

Soldering

Long Tail 13mm

Full Gold Plating

Ordering Information

	Number of Pin	Class 2	Class 3	Option
	32	N12501	N12501-3	
	16	N12503	N12503-3	2,4,6...32 5.08mm Pitch

Press Fit

Long Tail 13mm

Full Gold Plating

Ordering Information

	Number of Pin	Class 2	Class 3	Option
	32	N12601	N12601-3	
	16	N12603	N12603-3	2,4,6...32 5.08mm Pitch

Eurocard Connectors 2.54mm Pitch

Type B/2 (Half Sizes)

Right Angle Pin Assemblies

Material

Housing - Polyester, grey

Contacts - Copper Alloy

DIN Class 2 Plating - 15u" Gold Plating on Mating

Area. Tin Plating on Tail Area.

Nickel Underplate Allover



All dimensions in mm

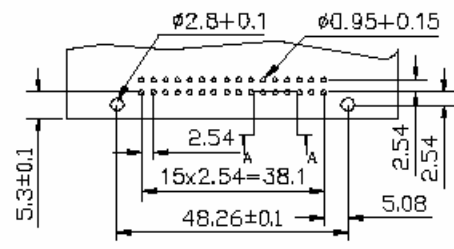
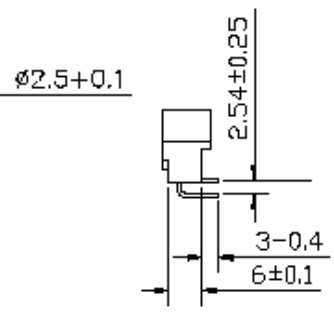
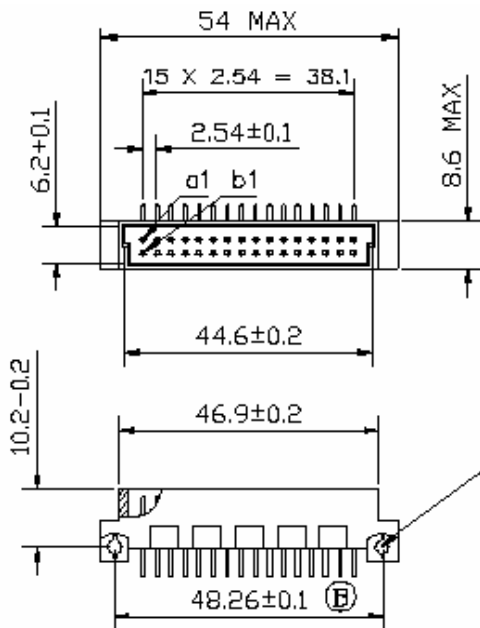

Recommended PCB Hole Layout

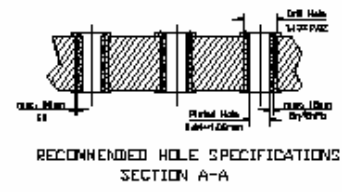

How to order

Part Number Information	I	II	III	IV - VI	VII
	N	1	3	xxx	-X
I	N - DIN 41612 Connectors				
II	1 - Type B	2 - Type C			
	3 - Type D	4 - Type E			
	5 - Type F	6 - Type H			
	7 - Type Q	8 - Type R			
	9 - Type M	0 - Accessories			
III	0 - Female	1 - Male			
	2 - 1/2 Sizes Female (B/2)	3 - 1/2 Sizes Male (B/2)			
	4 - 1/3 Size Female (B/3)	5 - 1/3 Size Male (B/3)			
	6 - Extend Size Female	7 - Extend Size Male			
	8 -	9 - Guide frame			
IV	xxx	Please Consult to Sales Representative to Fix the Optional			
VII	X	1- Class 1	3-Class 3	omit-Class 2	

Eurocard Connectors 2.54mm Pitch

Type B/2 (Half Sizes)

Right Angle Pin Assemblies

B/2 ab Row

Soldering

Ordering Information

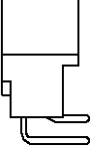
	Number of Pin	Class 2	Class 3	Option
	32	N13101	N13101-3	
	16	N13103	N13103-3	2,4,6...32 5.08mm Pitch

Soldering with clips

Ordering Information

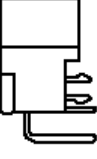
	Number of Pin	Class 2	Class 3	Option
	32	N13301	N13301-3	
	16	N13303	N13303-3	2,4,6...32 5.08mm Pitch

B/2 ab Row

Press-fit

Ordering Information

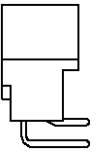
	Number of Pin	Class 2	Class 3	
	32	N13501	N13501-3	
	16	N13503	N13503-3	2,4,6...32 5.08mm Pitch
	Available upon request			

Eurocard Connectors 2.54mm Pitch

Type B/3 (1/3 Sizes)

Vertical Receptacle Assemblies

Material

Housing - Polyester, grey

Contacts - Copper Alloy

DIN Class 2 Plating - 15u" Gold Plating on Mating

Area. Tin Plating on Tail Area.

Nickel Underplate Allover

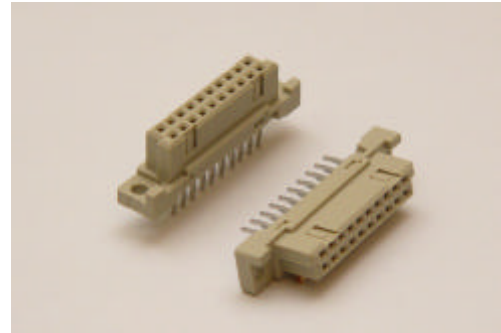

All dimensions in mm

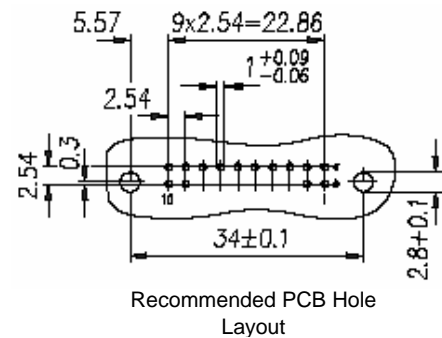
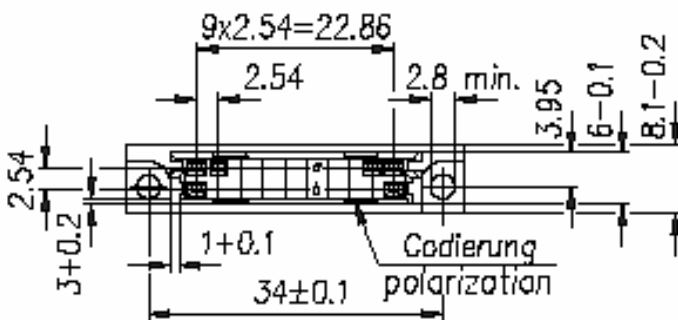
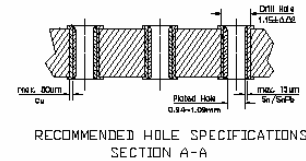
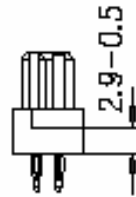
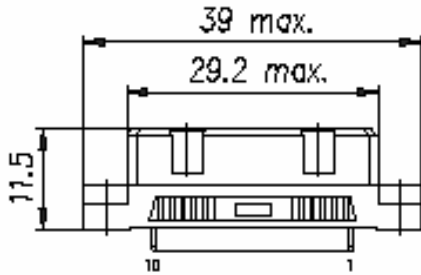

How to order

Part Number Information		I	II	III	IV - VI	VII
		N	1	4	xxx	-X
I	N - DIN 41612 Connectors					
II	1 - Type B	2 - Type C				
	3 - Type D	4 - Type E				
	5 - Type F	6 - Type H				
	7 - Type Q	8 - Type R				
	9 - Type M	0 - Accessories				
III	0 - Female	1 - Male				
	2 - 1/2 Sizes Female (B/2)	3 - 1/2 Sizes Male (B/2)				
	4 - 1/3 Size Female (B/3)	5 - 1/3 Size Male (B/3)				
	6 - Extend Size Female	7 - Extend Size Male				
	8 -	9 - Guide frame				
IV	xxx	Please Consult to Sales Representative to Fix the Optional				
VII	X	1 - Class 1	3 - Class 3	Omit - Class 2		

Eurocard Connectors 2.54mm Pitch

Type B/3 (1/3 Sizes)

Vertical Receptacle Assemblies

**B/3 ab Row
Soldering**

Ordering Information

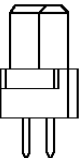
	Number of Pin	Class 2	Class 3	Option
	20	N14101	N14101-3	
	10	N14103	N14103-3	2,4,6...32 5.08mm Pitch

**B/3 ab Row
Press Fit**

Ordering Information

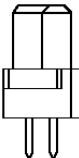
	Number of Pin	Class 2	Class 3	Option
	20	N14201	N14201-3	
	10	N14203	N14203-3	2,4,6...32 5.08mm Pitch

Soldering

Long Tail 13mm

Ordering Information

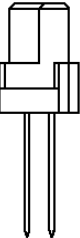
	Number of Pin	Class 2	Class 3	Option
	20	N14301	N14301-3	
	10	N14303	N14303-3	2,4,6...32 5.08mm Pitch

Press Fit

Long Tail 13mm

Ordering Information

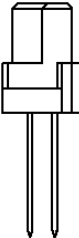
	Number of Pin	Class 2	Class 3	Option
	20	N14401	N14401-3	
	10	N14403	N14403-3	2,4,6...32 5.08mm Pitch

Soldering

Long Tail 13mm

Full Gold Plating

Ordering Information

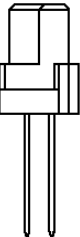
	Number of Pin	Class 2	Class 3	Option
	20	N14501	N14501-3	
	10	N14503	N14503-3	2,4,6...32 5.08mm Pitch

Press Fit

Long Tail 13mm

Full Gold Plating

Ordering Information

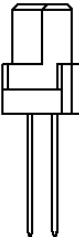
	Number of Pin	Class 2	Class 3	Option
	20	N14601	N14601-3	
	10	N14603	N14603-3	2,4,6...32 5.08mm Pitch

Eurocard Connectors 2.54mm Pitch

Type B/3 (1/3 Sizes)

Right Angle Pin Assemblies

Material

Housing - Polyester, grey

Contacts - Copper Alloy

DIN Class 2 Plating - 15u" Gold Plating on Mating Area. Tin Plating on Tail Area.

Nickel Underplate Allover

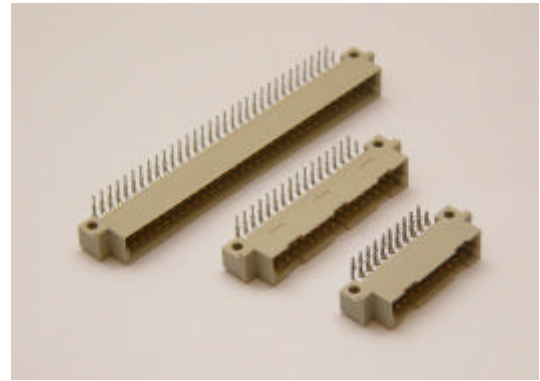

All dimensions in mm

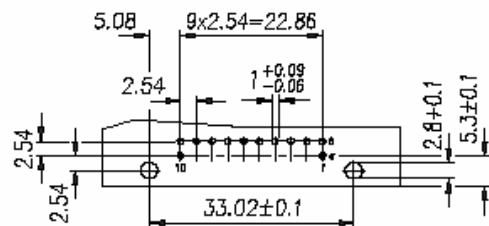
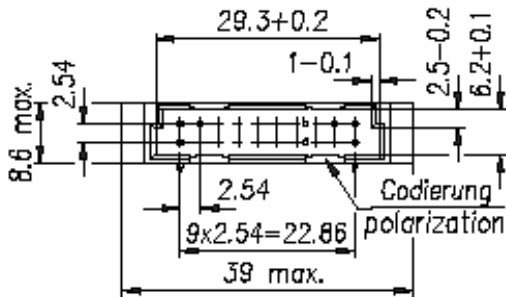

Recommended PCB Hole Layout

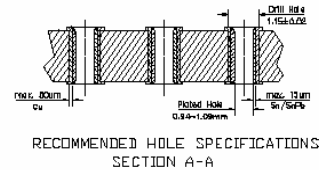
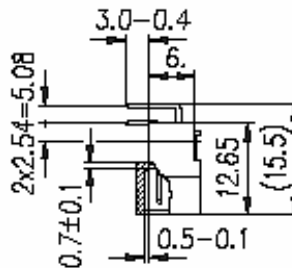
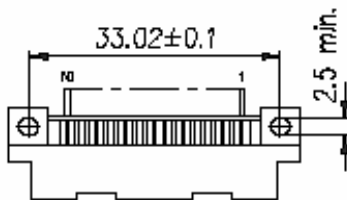

RECOMMENDED HOLE SPECIFICATIONS SECTION A-A

How to order

Part Number Information	I	II	III	IV - VI	VII
	N	1	5	xxx	-X
I	N - DIN 41612 Connectors				
II	1 - Type B		2 - Type C		
	3 - Type D		4 - Type E		
	5 - Type F		6 - Type H		
	7 - Type Q		8 - Type R		
	9 - Type M		0 - Accessories		
III	0 - Female		1 - Male		
	2 - 1/2 Sizes Female (B/2)		3 - 1/2 Sizes Male (B/2)		
	4 - 1/3 Size Female (B/3)		5 - 1/3 Size Male (B/3)		
	6 - Extend Size Female		7 - Extend Size Male		
	8 -		9 - Guide frame		
IV	xxx	Please Consult to Sales Representative to Fix the Optional			
VII	X	1- Class 1	3-Class 3	Omit-Class 2	

Eurocard Connectors 2.54mm Pitch

Type B/3 (1/3 Sizes)

Right Angle Pin Assemblies

B/3 ab Row

Soldering

Ordering Information

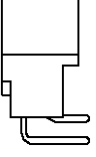
	Number of Pin	Class 2	Class 3	Option
	20	N15101	N15101-3	
	10	N15103	N15103-3	2,4,6...32 5.08mm Pitch

Soldering with clips

Ordering Information

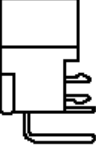
	Number of Pin	Class 2	Class 3	Option
	20	N15301	N15301-3	
	10	N15303	N15303-3	2,4,6...32 5.08mm Pitch

B/3 ab Row

Press-fit

Ordering Information

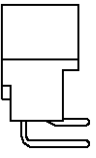
	Number of Pin	Class 2	Class 3	
	20	N15501	N15501-3	
	10	N15503	N15503-3	2,4,6...32 5.08mm Pitch
	Available upon request			